

GENERAL CATALOGUE CATÁLOGO GENERAL 2025

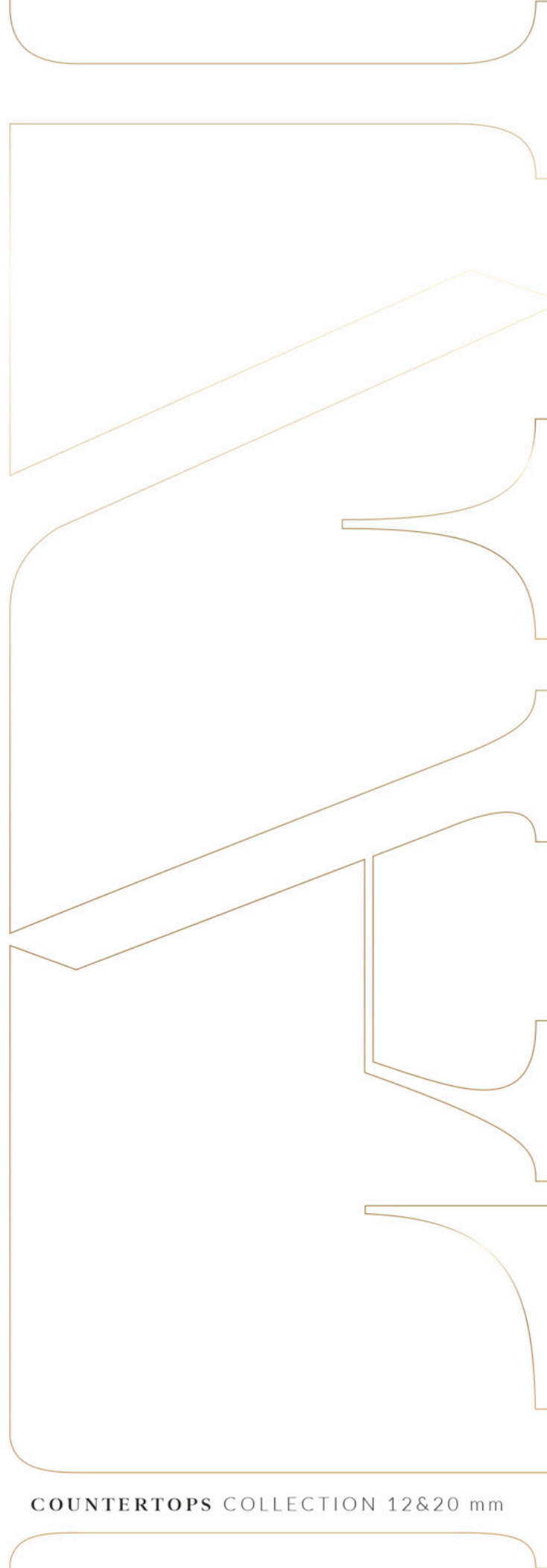

ARK
LANI

QUALITY DOESN'T FEAR TIME

PHILOSOPHY

FILOSOFÍA

Arklam arises to respond to the new needs of professionals in architecture and interior decoration.

With this vocation, Arklam has consolidated itself as a reference product for its exceptional technical features, which represent a step forward in the coating of all types of surfaces.

Arklam is an innovative solution of large format sintered mass, which stands out for its resistance, durability and design and which has been created specifically for the most exclusive and demanding projects.

Arklam surge para dar respuesta a las nuevas necesidades de los profesionales de la arquitectura y la decoración de interiores.

Con esta vocación, Arklam se ha consolidado como un producto de referencia por sus excepcionales prestaciones técnicas, que suponen un paso más allá en el recubrimiento de todo tipo de superficies.

Arklam es una innovadora solución de masa sinterizada de gran formato, que sobresale por su resistencia, durabilidad y diseño y que ha sido creada específicamente para los proyectos más exclusivos y exigentes.

www.arklam.com

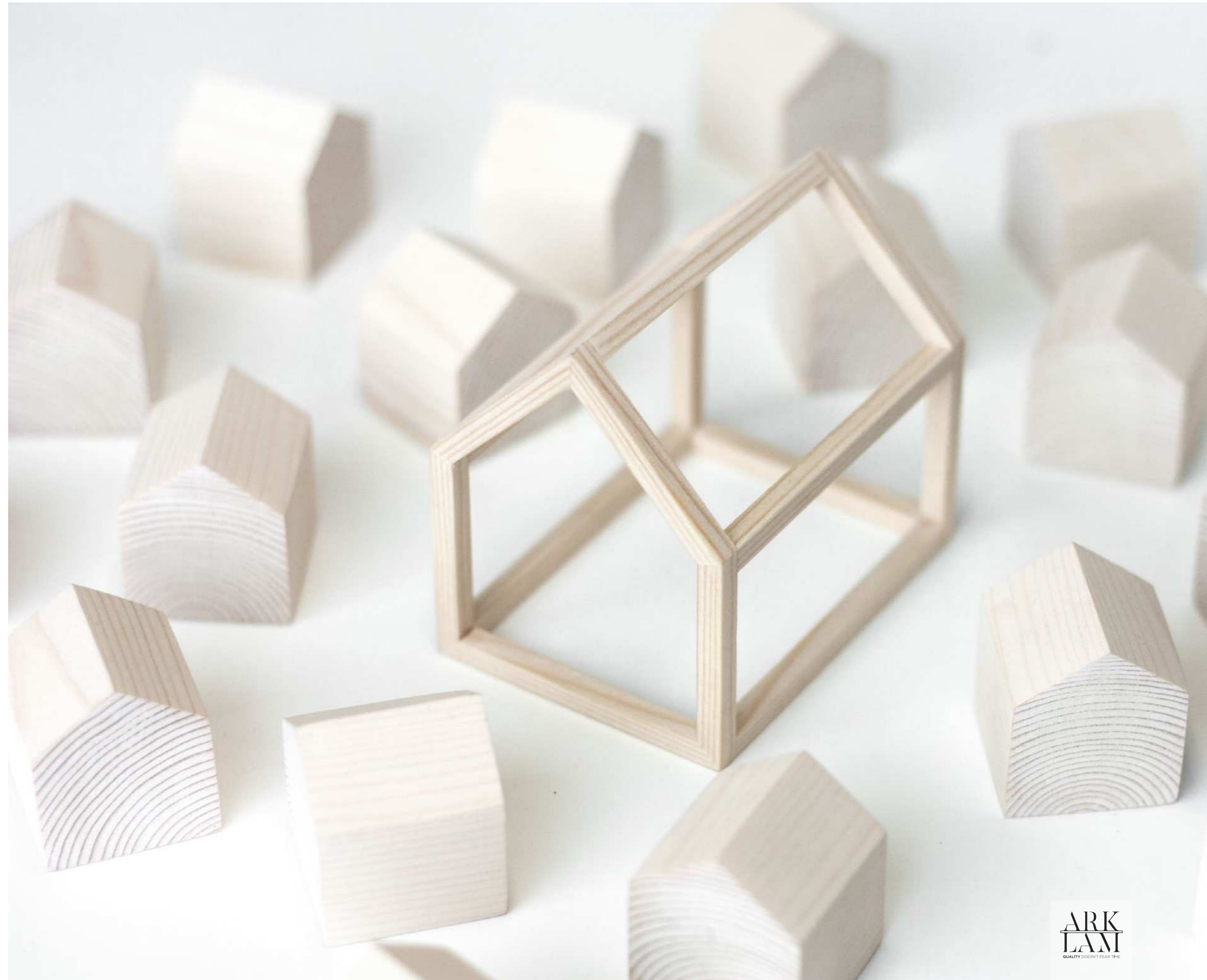



COUNTERTOP · Caviar Green Antique 1600x3200

ARKLAM FOR KITCHEN COUNTERTOPS

ARKLAM PARA ENCIMERAS DE COCINA

Arklam Countertops collection is a new sintered mass that provides solutions for kitchen countertop with character and personality. Born as a result of a deep study of decorative trends and the most contemporary demands.

Its large dimensions 1600x3200 mm, and the extremely high-performance technical features make it an ideal material for the most demanding product applications such as kitchen countertops.

100% Made in Spain

La colección Arklam Countertops es una nueva masa sinterizada que aporta soluciones para encimeras de cocinas con carácter y personalidad, nacida del profundo estudio de las tendencias decorativas y las demandas más contemporáneas.

Sus grandes dimensiones de 1600x3200 mm, y sus características técnicas de alto rendimiento lo convierten en un material idóneo para las aplicaciones más exigentes como son las encimeras de cocina.

100% Hecho en España

**ARK
LAMI**
Countertops
QUALITY DOESN'T FEAR TIME



COUNTERTOP · Negro Marquina Silk 1600x3200

GENERAL INDEX

ÍNDICE GENERAL

| | |
|---|------------|
| Arklam Collection / Colección Arklam | 8 |
| Format & Thickness / Formato y Espesor | 12 |
| Characteristics / Características | 14 |
| Arklam Induction / Arklam Inducción | 16 |
| Hypertouch | 18 |
| Our Collection 12&20mm / Nuestra Colección 12&20mm | 20 |
| Packing / Embalaje | 132 |
| Properties / Propiedades | 134 |
| Treatment of edges / Tratamiento de cantos | 134 |
| Cleaning / Limpieza | 136 |
| Technical Characteristics / Características Técnicas | 138 |
| Technical Characteristics Induction / Características Técnicas Inducción | 140 |
| Certifications & Awards / Certificados y Distinciones | 142 |

ARKLAM COLLECTION
COLECCIÓN ARKLAM

| COLLECTIONS | 1600x3200 | | | | | | | | 1200x3000 | | | | | | | | 1200x2800 | 1000x3000 | 1200x2600 | | | | |
|--------------------|-----------|------|------|---------|---------------|---------|----------|----------|-----------|------|---------|----------|------|------|---------|--------------|-----------|-----------|-----------|----------|------|----------|--|
| | 12 mm | | | | 20 mm | | | | 6 mm | | | | | | | | 6 mm | 6 mm | 6 mm | | | | |
| | POLISHED | SILK | HOND | NATURAL | BUSH HAMMERED | ANTIQUÉ | CASHMERE | POLISHED | SILK | HOND | NATURAL | POLISHED | SILK | HOND | NATURAL | RIVER WASHED | ANTIQUÉ | CASHMERE | NATURAL | POLISHED | SILK | POLISHED | |
| AMSTERDAM GREY | | | | • | | | | | | | | | | | | | | | | | | | |
| AQUA | | | | | | | | | | | • | | | | | | | | | | | | |
| ARCANE | | | | • | | | | | | | | | | | | | | | | | | | |
| ATLANTIS | • | • | | | | | | | | | | • | • | | | | | | | | | | |
| ATLANTIS GOLD | • | • | | | | | | | | | | • | • | | | | | | | | | | |
| ATRIUM BEIGE | | | | | | | | | | | | | | | • | | | | | | | | |
| ATRIUM PEARL | | | | | | | | | | | | | | | • | | | | | | | | |
| ATRIUM GREY | | | | | | | | | | | | | | | • | | | | | | | | |
| ATRIUM ANTHRACITE | | | | | | | | | | | | | | | • | | | | | | | | |
| AVENUE WHITE | | | | | | | | | | | | | • | | | | | | | | | | |
| AVENUE ASH | | | | | | | | | | | | | • | | | | | | | | | | |
| AVENUE TAUPE | | | | | | | | | | | | | • | | | | | | | | | | |
| AVENUE GRAPHITE | | | | | | | | | | | | | • | | | | | | | | | | |
| BASALT GREY | | • | | | | | | | | | | | | | | | | | | | | | |
| BATEIG BLUE | | | | • | | | | | | | | | | | • | | | | | | | | |
| BATEIG VERONA | | | | • | | | | | | | | | | | • | | | | | | | | |
| BOTANICAL COLD | | | | | | | | | | | | | | | | | | | | • | | | |
| BOTANICAL WARM | | | | | | | | | | | | | | | | | | | | • | | | |
| BRAZIL SUPER WHITE | | | | • | | | | | | | | | | • | | | | | | | | | |
| CALACATTA GOLD | | | | • | | | | | | | | • | | • | | | | | | | | | |
| CALACATTA GREEN | | | | | | | | | | | | • | | • | | | | | | | | | |
| CALACATTA PAONAZZO | • | | • | | | | | • | | • | • | | • | | • | | | | | | | | |
| CANADA | | • | | | | | | | | | | | | | | | | | | | | | |
| CAVIAR GREEN | | | | | | • | | | | | | • | | | | | • | | | | | | |
| CAVIAR GREEN DECOR | | | | | | | | | | | | | | | | | • | | | | | | |

| COLLECTIONS | 1600x3200 | | | | | | | | 1200x3000 | | | | | | | | 1200x2800 | 1000x3000 | 1200x2600 | | | | |
|-------------------|-----------|------|------|---------|---------------|---------|----------|----------|-----------|------|---------|----------|------|------|---------|--------------|-----------|-----------|-----------|----------|------|----------|--|
| | 12 mm | | | | 20 mm | | | | 6 mm | | | | | | | | 6 mm | 6 mm | 6 mm | | | | |
| | POLISHED | SILK | HOND | NATURAL | BUSH HAMMERED | ANTIQUÉ | CASHMERE | POLISHED | SILK | HOND | NATURAL | POLISHED | SILK | HOND | NATURAL | RIVER WASHED | ANTIQUÉ | CASHMERE | NATURAL | POLISHED | SILK | POLISHED | |
| ESTUARIO | • | | • | | | | | • | | • | | | | | | | | | | | | | |
| FIORI DE LUNA | | | | | | | | | | | | | | | • | | | | | | | | |
| GARLAND BEIGE | | | | | | | | | | | | | | | | | | | | | • | | |
| GARLAND SAND | | | | | | | | | | | | | | | | | | | | | • | | |
| GARLAND HAZELNUT | | | | | | | | | | | | | | | | | | | | | • | | |
| GARLAND PEARL | | | | | | | | | | | | | | | | | | | | | • | | |
| GARLAND SILVER | | | | | | | | | | | | | | | | | | | | | • | | |
| GARLAND GREY | | | | | | | | | | | | | | | | | | | | | • | | |
| GARLAND DARK GREY | | | | | | | | | | | | | | | | | | | | | • | | |
| GRIS LEVANTE | | | | | | | | | | | | | | | | • | | | | | | | |
| INVISIBLE GREY | • | | • | | | | | | | | | | | | | | | | | | | | |
| JURASSIC BLACK | | | | | | | | | | | | | | | | | | | | • | | | |
| JURASSIC GOLD | | | | | | | | | | | | | | | | | | | | • | | | |
| LILAC | | | | • | | | | | | • | | | | • | | | | | | | | | |
| LONDRA BLACK | | | | | | | | | | | | | | | | | | | | | • | | |
| LONDRA GREY | | | | | | | | | | | | | | | | | | | | | • | | |
| MANHATTAN WHITE | | | | | | | | | | | | | | | | | | | | | • | | |
| MANHATTAN BEIGE | | | | | | | | | | | | | | | | | | | | | • | | |
| MANHATTAN GREY | | | | | | | | | | | | | | | | | | | | | • | | |
| MAYFAIR OAK | | | | | | | | | | | | | | | | | | | | | | • | |
| MELBOURNE | | | | • | | | | | | | | | | | | | | | | | | • | |
| MELBOURNE DECOR | | | | | | | | | | | | | | | | | | | | | | • | |
| MIRAGE GREY | | | | | | | | | | | | | | | | | | | | | | | |
| MYSTIC GREY | | | | | | | | | | | | | | | | | | | | • | | • | |
| NATIVA BEIGE | | | | | | | | | | | | | | | | | | | | | | • | |

ARKLAM COLLECTION
COLECCIÓN ARKLAM

| COLLECTIONS | 1600x3200 | | | | | | | | 1200x3000 | | | | | | | | 1200x2800 | 1000x3000 | 1200x2600 | | | | |
|----------------------|-----------|------|------|---------|---------------|---------|----------|----------|-----------|------|---------|----------|------|------|---------|--------------|-----------|-----------|-----------|----------|------|----------|---|
| | 12 mm | | | | 20 mm | | | | 6 mm | | | | 6 mm | 6 mm | 6 mm | | | | | | | | |
| | POLISHED | SILK | HOND | NATURAL | BUSH HAMMERED | ANTIQUE | CASHMERE | POLISHED | SILK | HOND | NATURAL | POLISHED | SILK | HOND | NATURAL | RIVER WASHED | ANTIQUE | CASHMERE | NATURAL | POLISHED | SILK | POLISHED | |
| NATIVA GREIGE | | | | • | | | | | | | | | | | • | | | | | | | | |
| NATIVA WHITE | | | | • | | | | | | | | | | | • | | | | | | | | |
| NEGRO MARQUINA | • | • | | | | | | | | | | • | • | | | | | | | | | • | |
| OMNIA WHITE | | | | | | | | | | | | • | | • | | | | | | | | | |
| ONICE BLACK | | | | | | | | | | | | • | | | | | | | | | | | |
| ONIX BEIGE | | | | | | | | | | | | • | | | | | | | | | | | |
| ONIX JADE | | | | | | | | | | | | • | | | | | | | | | | | |
| ONIX PEARL | | | | | | | | | | | | • | | | | | | | | | | | |
| ONIX TURQUOISE | | | | | | | | | | | | • | | | | | | | | | | | • |
| PALISANDRO BLUE | | | | | | | | | | | | | | | | | | | | | • | | |
| PANDORA | | | | | | | | | | | | | • | | | | | | | | • | • | |
| PATAGONIA GOLD | | | | | | | • | | | | | • | | | | | • | | | | | | |
| PHOENIX BLUE | | | | | | | | | | | | | • | | | | | | | | | | |
| PIER17 COPPER | | | | | | | | | | | | | | | • | | | | | | | | |
| PIER17 ZINC | | | | | | | | | | | | | | | • | | | | | | | | |
| PIETRA CORAL | | | | | | | | | | | | | | | • | | | | | | | | |
| PIETRA CORAL PEARL | | | | | | | | | | | | | | | • | | | | | | | | |
| PIETRA CORAL SAND | | | | | | | | | | | | | | | • | | | | | | | | |
| POMPEIA | | | | | | | | | | | | | | | | | | | | | | • | |
| PORTLAND STONE | | | | | | | | | | | | | | | • | | | | | | | | |
| PORTLAND STONE BEIGE | | | | | | | | | | | | | | | • | | | | | | | | |
| PORTOBELLO | | | | | | | | | | | | • | • | | | | | | | | • | • | |
| PULPIS NATURAL | | • | | | | | | | | | | | • | | | | | | | | | • | |
| PURE BLACK | | | • | | | | | | | | | | • | | | | | | | | | | |
| PURE GREY | | | | | | | | | | | | | • | | | | | | | | | | |

| COLLECTIONS | 1600x3200 | | | | | | | | 1200x3000 | | | | | | | | 1200x2800 | 1000x3000 | 1200x2600 | | | | |
|-------------------|-----------|------|------|---------|---------------|---------|----------|----------|-----------|------|---------|----------|------|------|---------|--------------|-----------|-----------|-----------|----------|------|----------|--|
| | 12 mm | | | | 20 mm | | | | 6 mm | | | | 6 mm | 6 mm | 6 mm | | | | | | | | |
| | POLISHED | SILK | HOND | NATURAL | BUSH HAMMERED | ANTIQUE | CASHMERE | POLISHED | SILK | HOND | NATURAL | POLISHED | SILK | HOND | NATURAL | RIVER WASHED | ANTIQUE | CASHMERE | NATURAL | POLISHED | SILK | POLISHED | |
| PURE SUPER WHITE | | | • | | | | | | | | • | | | | | | | | | | | | |
| PURE WHITE | | | | | | | | | | | | | • | | | | | | | | | | |
| ROSA PERSIA | | | • | | | | | | | | | • | | • | | | | | | | | | |
| SAHARA NOIR | | | • | | | | | | | | | • | • | | | | | | | | | | |
| SAINT LAURENT | | | | • | | | | | | | | | | • | | | | | | | | | |
| SEVEN BEIGE | | | | | | | | | | | | | | | | | | | | | | • | |
| SEVEN SAND | | | | | | | | | | | | | | | | | | | | | | • | |
| SEVEN HAZELNUT | | | | • | | | | | | | | | | | | | | | | | | • | |
| SEVEN PEARL | | | | | | | | | | | | | | | | | | | | | | • | |
| SEVEN SILVER | | | | | | | | | | | | | | | | | | | | | | • | |
| SEVEN GREY | | | | | | | | | | | | | | | | | | | | | | • | |
| SEVEN DARK GREY | | | | | | | | | | | | | | | | | | | | | | • | |
| SYRAC | | | • | | | | | | | | | | • | | • | | | | | | • | | |
| TRAVERTINE GREY | | | | | | | | | | | | | | | | • | | | | | | | |
| TRAVERTINO NAVONA | | | | | | | | | | | | | | | | | • | | | | | | |
| TUNDRA CREAM | | | | • | | | | | | | | | | | | • | | | | | | | |
| TUNDRA GREIGE | | | | • | | | | | | | | | | | | • | | | | | | | |
| VULCANO | | | | | | | | | | | | | • | | | | | | | | | | |



COUNTERTOP · Melbourne Hond 1600x3200

FORMAT & THICKNESS

FORMATO Y ESPESOR

1600x3200 mm 63"x 126"



SINTERED MASS COLOURED BODY MASA SINTERIZADA COLOREADA

Arklam Countertops is a sintered mass coloured body with which we created amazing designs for countertops of sophisticated kitchens in different finishes:

- Polished: A mirror-like glossy finish that reflects great depth and vibrancy of colour.
- Silk: A soft, matte finish.
- Bush Hammered: A rough effect resembling natural stone.
- Natural: The most authentic representation of the original material.
- Hond: An ultra-soft, matte finish with a silky effect.
- Antique: Reveals the natural ageing and authentic passage of time.
- Cashmere: A polished matte finish with a velvety texture reminiscent of marble.

Arklam Countertops es una masa sinterizada coloreada con la que podemos conseguir diseños totalmente integrados para la creación de encimeras de cocinas sofisticadas gracias a sus acabados:

- Polished, acabado brillo espejo que refleja una gran profundidad y viveza del color.
- Silk, acabado mate suave.
- Bush Hammered, efecto abujardado tipo piedra natural.
- Natural, el efecto más fiel al material original.
- Hond, acabado mate muy suave efecto seda.
- Antique, revela el envejecido natural y el auténtico paso del tiempo.
- Cashmere, efecto pulido mate que ofrece una textura aterciopelada como el mármol.

ARK
LAM

12 MM & 20 MM



CHARACTERISTICS

CARACTERÍSTICAS

Because variety is important, Arklam Super Size Collection allows you to choose from a rich diversity of designs of all styles. Each series presents differentiated graphics to obtain personalized and plentiful finishes in shades.

Porque en la variedad está el gusto, Arklam Super Size Collection permite elegir entre una rica diversidad de diseños de todos los estilos. Cada serie presenta gráficas diferenciadas para obtener acabados personalizados y abundantes en matices.

Big in size, big in performance.
With Arklam all the advantages are XXL.

Grande en tamaño, grande en prestaciones.
Con Arklam todas las ventajas son XXL.

Arklam it's an absolute trend. Exclusivity and avant-garde aesthetics to dress every space in a modern way. Arklam is fashion with a timeless character.

Arklam es absoluta tendencia. Exclusividad y estética vanguardista para vestir de plena actualidad cada espacio. Arklam es moda con carácter atemporal.

Arklam is the result of a constant commitment to technological innovation. The latest advances in R+D incorporated into the manufacturing process allow us to enjoy a product with extraordinary qualities.

Arklam es el resultado de una constante apuesta por la innovación tecnológica. Los últimos avances en I+D incorporados al proceso de fabricación permiten disfrutar de un producto con cualidades extraordinarias.

With Arklam your countertops will be hygienic and safe thanks to its anti-fungal and anti-bacterial properties.

Con Arklam tus encimeras serán higiénicas y seguras gracias a sus propiedades antibacterianas contra hongos y bacterias.



DESIGN
DISEÑO



SUPER SIZE
GRAN FORMATO



EXCLUSIVITY
EXCLUSIVIDAD



INNOVATION
INNOVACIÓN



BACTERICIDAL EFFECT
EFECTO BACTERICIDA



COUNTERTOP · Saint Laurent Natural 1600x3200

ARK
LAM
QUALITY CREDIT FEAR THE



At Arklam, we are committed to innovation and excellence in designing home solutions that make a difference. After a lengthy research process, we are excited to introduce a true revolution in the world of cooking: **our new hidden induction system for countertops.**

We love to envision a kitchen free from visual obstructions, where the beauty of the Arklam countertop remains impeccably intact. With our hidden induction system, that vision becomes a reality. It is no longer necessary to sacrifice aesthetics for functionality: now, you can enjoy the best of both worlds.

100% Made in Spain

En Arklam estamos comprometidos con la innovación y la excelencia en el diseño de soluciones para el hogar que marcan la diferencia. Tras un largo proceso de investigación, estamos emocionados de presentar una verdadera revolución en el mundo de la cocina: **nuestro nuevo sistema de inducción oculta para encimeras.**

Nos encanta imaginar una cocina sin obstáculos visuales, donde la belleza de la encimera Arklam se mantiene impecablemente intacta. Con nuestro sistema de inducción oculta, esa visión se convierte en realidad. Ya no será necesario sacrificar la estética por la funcionalidad: ahora se puede disfrutar de lo mejor de ambos mundos.

100% Hecho en España



COUNTERTOP - Tundra Greige Natural 1600x3200





COUNTERTOP · Nativa White Natural 1600x3200

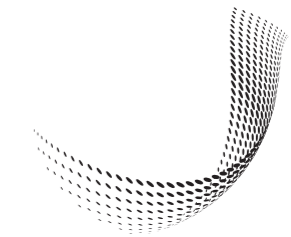

Hypertouch

Discover redefined innovation with Hypertouch, the new product range from Arklam. With a meticulous focus on effects and textures, Hypertouch represents the culmination of the latest technological advances in the digital application of enamels and finishes.

Each piece is precisely designed to offer a unique visual and tactile experience. Our dedication to the details is reflected in the creation of stunning effects that transform any space into a modern environment.

Experience perfection in every surface with Hypertouch. From a natural feel to subtle nuances, our range of colours offers an endless variety to meet your design requirements. Furthermore, our carefully designed textures add depth and character to any project by synchronising the graphics with the relief.

With Hypertouch, we're taking ceramics to a new level of excellence and an extreme reality in our products. Join us on this journey towards innovation and discover how our advanced technologies are redefining industry standards.

Welcome to the future of ceramics with Hypertouch by Arklam.

Descubre la innovación redefinida con Hypertouch, la nueva línea de productos de Arklam. Con un enfoque meticuloso de los efectos y las texturas, Hypertouch representa la culminación de los últimos avances tecnológicos en la aplicación digital de esmaltes y acabados.

Cada pieza está diseñada con precisión para ofrecer una experiencia visual y táctil única. Nuestra dedicación al detalle se refleja en la creación de efectos sorprendentes que transforman cualquier espacio en un ambiente de vanguardia.

Experimenta la perfección en cada superficie con Hypertouch. Desde un tacto natural hasta sutiles matices, nuestra gama de colores ofrece una variedad infinita para satisfacer tus necesidades de diseño. Además, nuestras texturas cuidadosamente elaboradas añaden profundidad y carácter a cualquier proyecto sincronizando la grafica con el relieve.

Con Hypertouch, **estamos llevando la cerámica a un nuevo nivel de excelencia y a una realidad extrema en nuestros productos.** Únete a nosotros en este viaje hacia la innovación y descubre cómo nuestras tecnologías avanzadas están redefiniendo los estándares en la industria.

Bienvenido al futuro de la cerámica con Hypertouch de Arklam.

OUR COLLECTION

NUESTRA COLECCIÓN

Marbles/ Mármoles



22 ATLANTIS POLISHED / SILK 1600x3200 12 mm
 26 ATLANTIS GOLD POLISHED / SILK 1600x3200 12 mm
 30 BRAZIL SUPER WHITE HOND 1600x3200 12 mm
 34 CALACATTA GOLD HOND 1600x3200 12&20mm
 38 CALACATTA PAONAZZO POLISHED / HOND 1600x3200 12&20mm
 42 CAVIAR GREEN ANTIQUE 1600x3200 12mm
 46 ESTUARIO POLISHED / HOND 1600x3200 12&20mm
 50 INVISIBLE GREY POLISHED / HOND 1600x3200 12mm



52 LILAC HOND 1600x3200 12&20mm
 56 MELBOURNE HOND 1600x3200 12mm
 58 NATIVA WHITE NATURAL 1600x3200 12mm
 60 NATIVA BEIGE NATURAL 1600x3200 12mm
 62 NATIVA GREIGE NATURAL 1600x3200 12mm
 66 NEGRO MARQUINA POLISHED / SILK 1600x3200 12mm
 68 PATAGONIA GOLD CASHMERE 1600x3200 12mm
 72 PULPIS NATURAL SILK 1600x3200 12mm

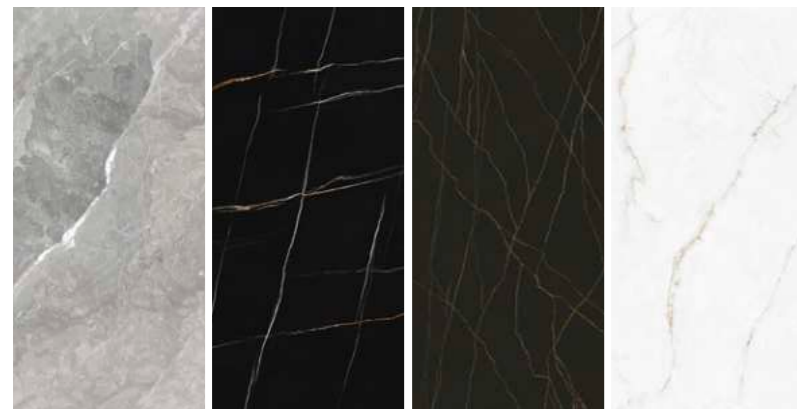

74 ROSA PERSIA HOND 1600x3200 12mm
 78 SAHARA NOIR HOND 1600x3200 12mm
 80 SAINT LAURENT NATURAL 1600x3200 12&20mm
 84 SYRAC HOND 1600x3200 12&20mm

Concrete & Stones/ Cementos y piedras



88 AMSTERDAM GREY NATURAL 1600x3200 12mm
 92 BASALT GREY SILK 1600x3200 12mm
 94 BATEIG BLUE NATURAL 1600x3200 12mm
 98 BATEIG VERONA NATURAL 1600x3200 12mm
 102 GRIS LEVANTE NATURAL 1600x3200 12mm
 104 MANHATTAN GREY SILK 1600x3200 12mm



106 MIRAGE GREY BUSH HAMMERED 1600x3200 12mm
 110 SEVEN HAZELNUT NATURAL 1600x3200 12mm
 112 TUNDRA CREAM NATURAL 1600x3200 12mm
 114 TUNDRA GREIGE NATURAL 1600x3200 12mm
 118 VULCANO SILK 1600x3200 20mm

Wood/ Madera



120 ARCANE NATURAL 1600x3200 12mm
 124 CANADA SILK 1600x3200 12mm

Basic Line

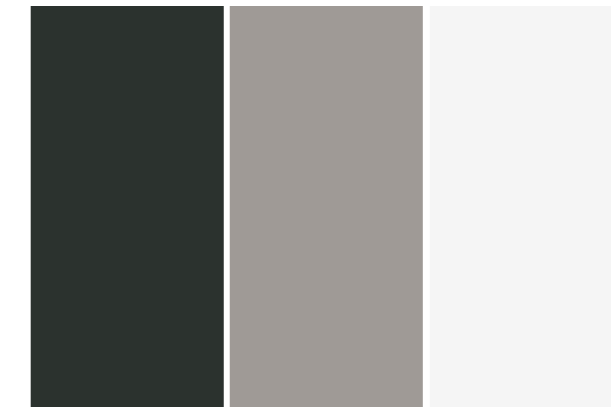

126 PURE BLACK HOND 1600x3200 12&20mm
 128 PURE GREY HOND 1600x3200 20mm
 130 PURE SUPER WHITE HOND 1600x3200 12&20mm



ARK
LAMI

A T L A N T I S

▼
6 mm

▲
POLISHED / SILK

1200x3000 mm/ 47,2"x118"
Atlantis Polished 1200x3000 Rect.
Atlantis Silk 1200x3000 Rect.

9 DESIGNS / 9 DISEÑOS

▼
12 mm

▲
POLISHED / SILK

1600x3200 mm/ 63"x126"
Atlantis Polished 1600x3200
Atlantis Silk 1600x3200

2 DESIGNS / 2 DISEÑOS

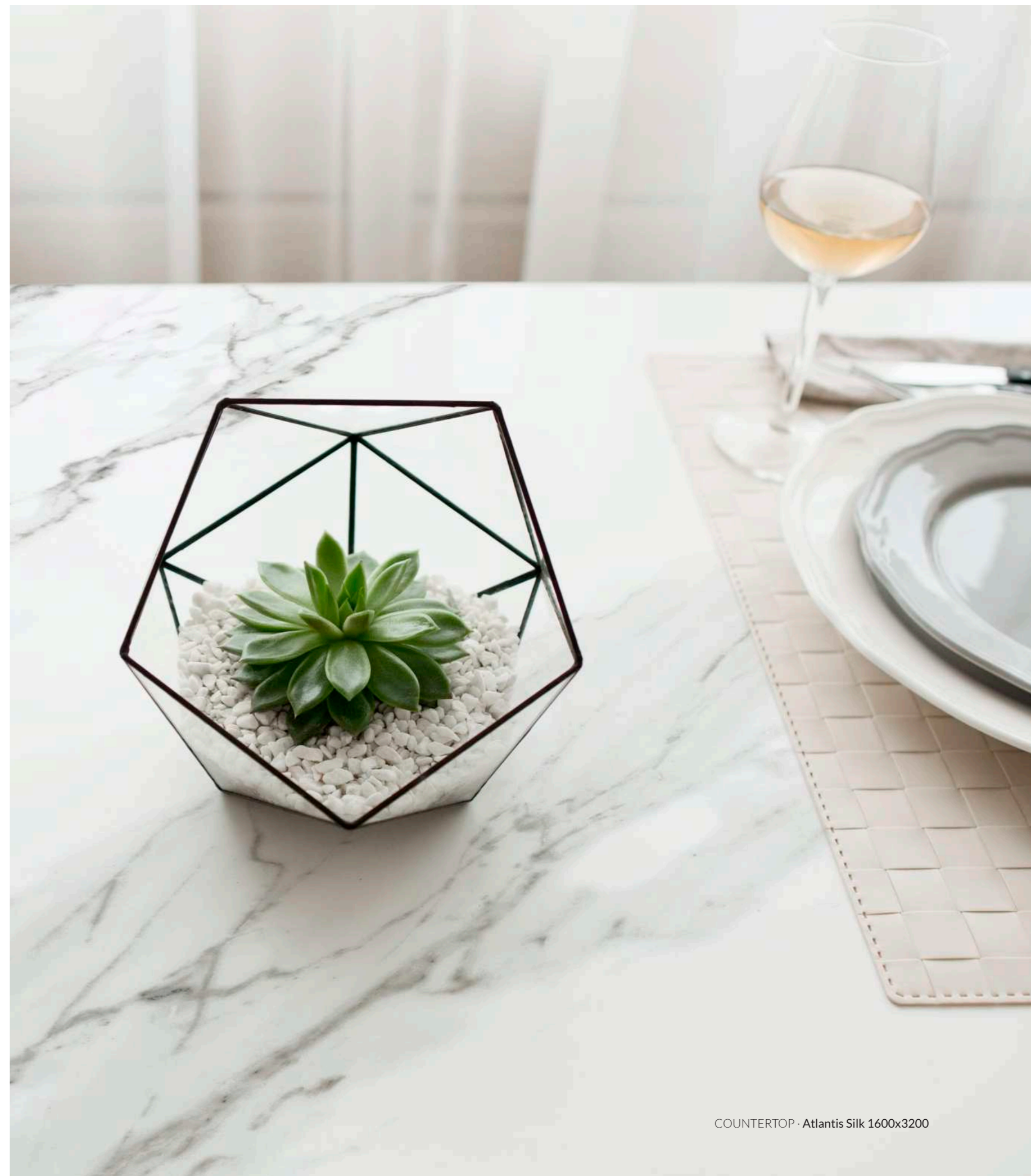

COUNTERTOP · Atlantis Silk 1600x3200

ATLANTIS

OPENBOOK

- ▶ The pieces reflect each other as if they were an open book.
When purchasing two graphics, different models will always be received, forming an Openbook.
Las piezas se reflejan entre sí como si fueran un libro abierto.
Al adquirir dos gráficas, siempre se recibirán modelos diferentes que forman Openbook.



COUNTERTOP & BACKSPLASH · Atlantis Polished 1600x3200
FLOOR · Atlantis Polished 1200x3000 Rect.





ARK
LAMI

ATLANTIS GOLD

▼
6 mm

▲
POLISHED / SILK

1200x3000 mm/ 47,2"x118"
Atlantis Gold Polished 1200x3000 Rect.
Atlantis Gold Silk 1200x3000 Rect.

9 DESIGNS / 9 DISEÑOS

▼
12 mm

▲
POLISHED / SILK

1600x3200 mm/ 63"x126"
Atlantis Gold Polished 1600x3200
Atlantis Gold Silk 1600x3200

2 DESIGNS / 2 DISEÑOS



WALL - Atlantis Gold Silk 1200x3000 Rect.
FLOOR - Atlantis Gold Polished 1200x3000 Rect.
COUNTERTOP - Atlantis Gold Silk 1600x3200

ATLANTIS GOLD

OPENBOOK

- The pieces reflect each other as if they were an open book.
When purchasing two graphics, different models will always be received, forming an Openbook.
Las piezas se reflejan entre sí como si fueran un libro abierto.
Al adquirir dos gráficas, siempre se recibirán modelos diferentes que forman Openbook.



COUNTERTOP & BACKSPLASH · Atlantis Gold Polished 1600x3200





BRAZIL SUPER WHITE

ARK
LAMI

6 mm

HOND

1200x3000 mm/ 47,2"x118"
Brazil Super White Hond 1200x3000 Rect.

3 DESIGNS / 3 DISEÑOS

12 mm

HOND

1600x3200 mm/ 63"x126"
Brazil Super White Hond 1600x3200

1 SINGLE DESIGN / 1 ÚNICO DISEÑO



COUNTERTOP · Brazil Super White Hond 1600x3200
FLOOR · Irati Natural Matt 25x150 Rect.



COUNTERTOP & BACKSPLASH · Brazil Super White Hond 1600x3200
FURNITURE · Pure Black Silk 1200x3000 Rect.
FLOOR · Irati Natural Matt 25x150 Rect.



CALACATTA GOLD

6 mm

POLISHED / HOND

1200x3000 mm/ 47,2"x118"
 Calacatta Gold Polished 1200x3000 Rect.
 Calacatta Gold Hond 1200x3000 Rect.

3 DESIGNS / 3 DISEÑOS

12&20 mm

HOND

1600x3200 mm/ 63"x126"
 Calacatta Gold Hond 1600x3200

1 SINGLE DESIGN / 1 ÚNICO DISEÑO



COUNTERTOP & BACKSPLASH - Calacatta Gold Hond 1600x3200





FLOOR & BACKSPLASH • Calacatta Gold Hond 1200x3000 Rect.
COUNTERTOP • Calacatta Gold Hond 1600x3200





CALACATTA PAONAZZO

ARK
LAMI

▼
6 mm

▲
POLISHED / HOND

1200x3000 mm/ 47,2"x118"
Calacatta Paonazzo Polished 1200x3000 Rect.
Calacatta Paonazzo Hond 1200x3000 Rect.

3 DESIGNS / 3 DISEÑOS

▼
12&20 mm

▲
HOND

1600x3200 mm/ 63"x126"
Calacatta Paonazzo Polished 1600x3200
Calacatta Paonazzo Hond 1600x3200

2 DESIGNS / 2 DISEÑOS



COUNTERTOP & BACKSPLASH · Calacatta Paonazzo Polished 1600x3200
FLOOR · Calacatta Paonazzo Polished 1200x3000 Rect.

CALACATTA PAONAZZO

OPENBOOK

- The pieces reflect each other as if they were an open book.
When purchasing two graphics, different models will always be received, forming an Openbook.
Las piezas se reflejan entre sí como si fueran un libro abierto.
Al adquirir dos gráficas, siempre se recibirán modelos diferentes que forman Openbook.

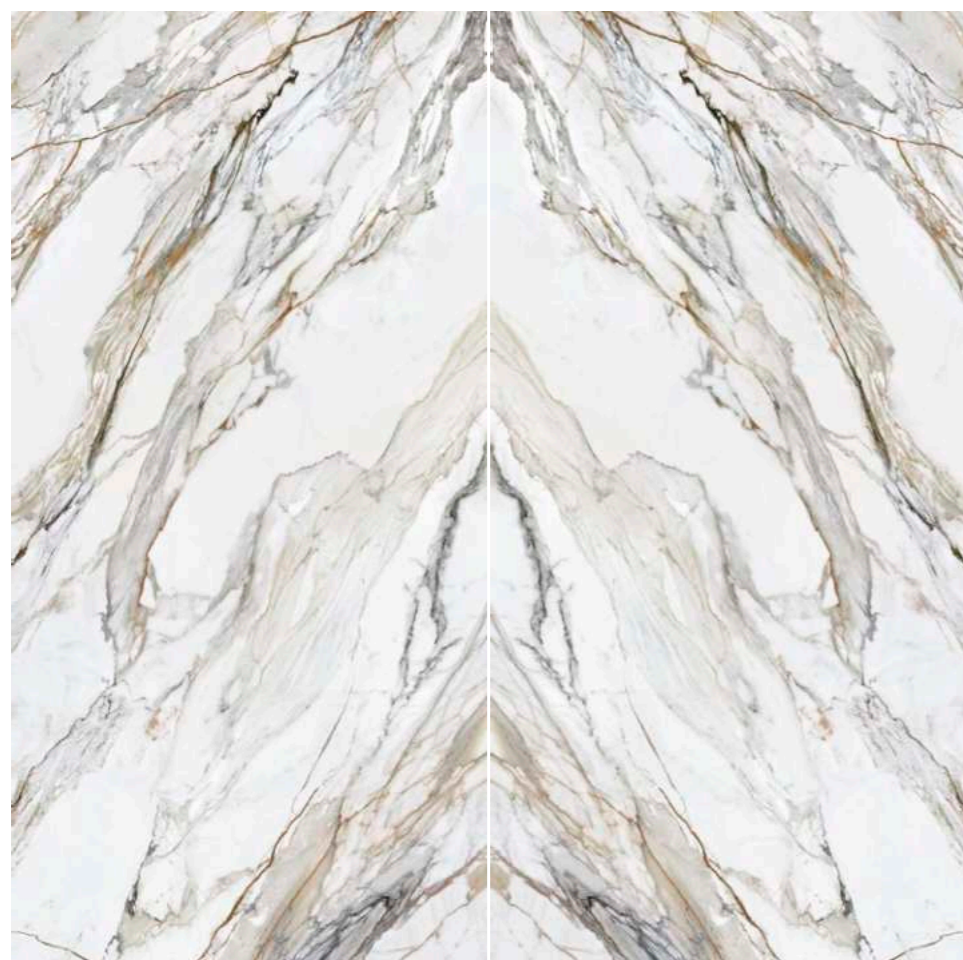

FLOOR - Pure Black Silk 1200x3000 Rect.
COUNTERTOP - Calacatta Paonazzo Polished 1600x3200 / Canada Silk 1600x3200

ARK
LAMI
QUALITY CREDIT FEEL THE

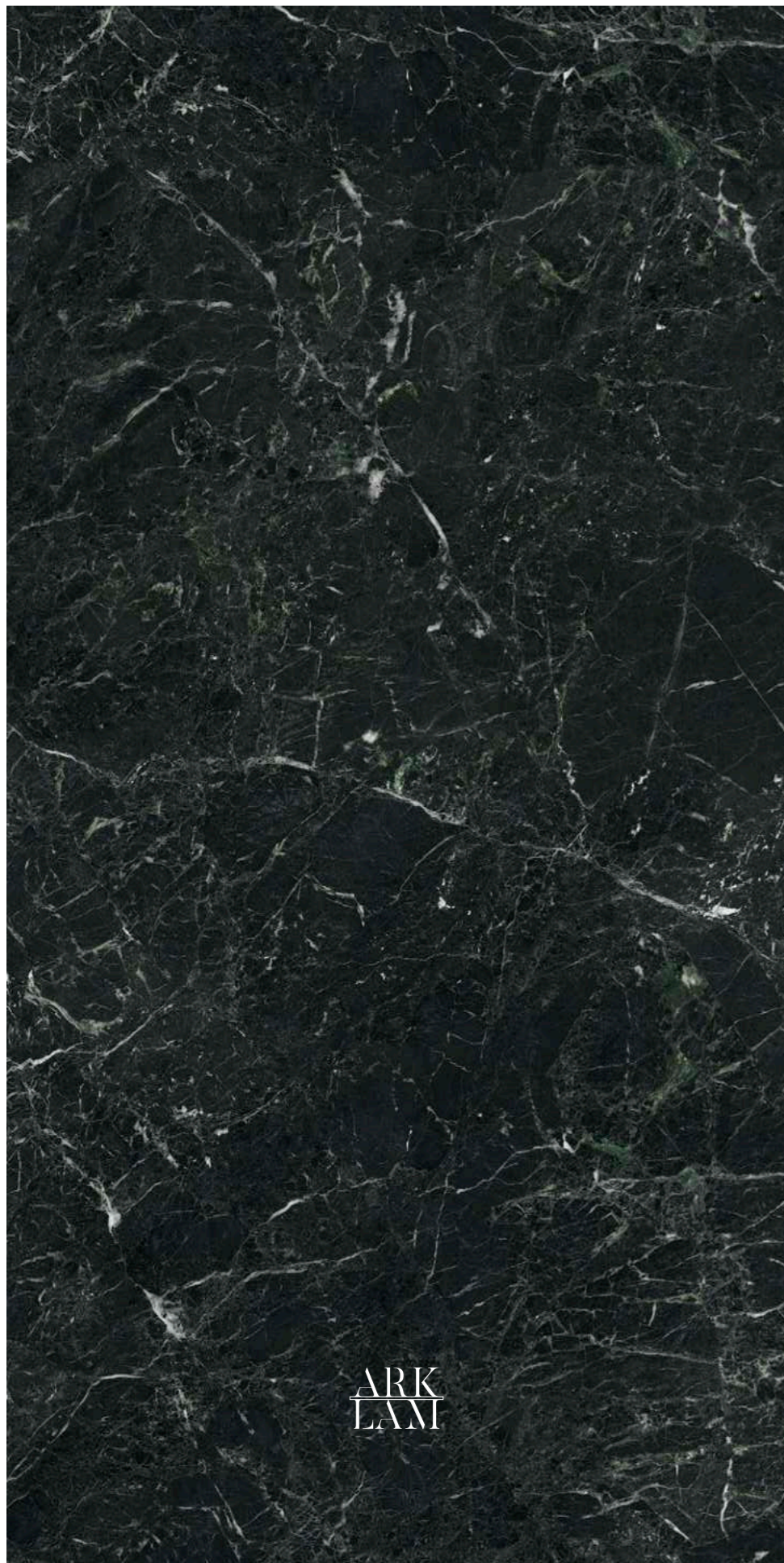

C A V I A R G R E E N

ARK
LAMI

▼
6 mm

▲
POLISHED / ANTIQUE

1200x3000 mm/ 47,2"x118"
Caviar Green Polished 1200x3000 Rect.
Caviar Green Antique 1200x3000 Rect.

6 DESIGNS / 6 DISEÑOS

▼
12 mm

▲
ANTIQUÉ

1600x3200 mm/ 63"x126"
Caviar Green Antique 1600x3200

1 SINGLE DESIGN / 1 ÚNICO DISEÑO



COUNTERTOP · Caviar Green Antique 1600x3200
FLOOR · Caviar Green Antique 1200x3000 Rect.



WALL & FLOOR - Caviar Green Antique 1200x3000 Rect.
COUNTERTOP - Caviar Green Antique 1600x3200

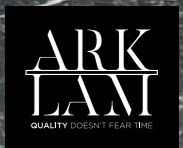



ARK
LAMI

E S T A T U A R I O

▼
6 mm

▲
POLISHED / HOND

1200x3000 mm/ 47,2"x118"
Estatuario Polished 1200x3000 Rect.
Estatuario Hond 1200x3000 Rect.

6 DESIGNS / 6 DISEÑOS

▼
12&20 mm

▲
POLISHED / HOND

1600x3200 mm/ 63"x126"
Estatuario Polished 1600x3200
Estatuario Hond 1600x3200

2 DESIGNS / 2 DISEÑOS



COUNTERTOP · Estatuario Hond 1600x3200
FLOOR · Irati Natural Matt 25x150 Rect.

ESTATUARIO

OPENBOOK

- The pieces reflect each other as if they were an open book.
When purchasing two graphics, different models will always be received, forming an Openbook.
Las piezas se reflejan entre sí como si fueran un libro abierto.
Al adquirir dos gráficas, siempre se recibirán modelos diferentes que forman Openbook.

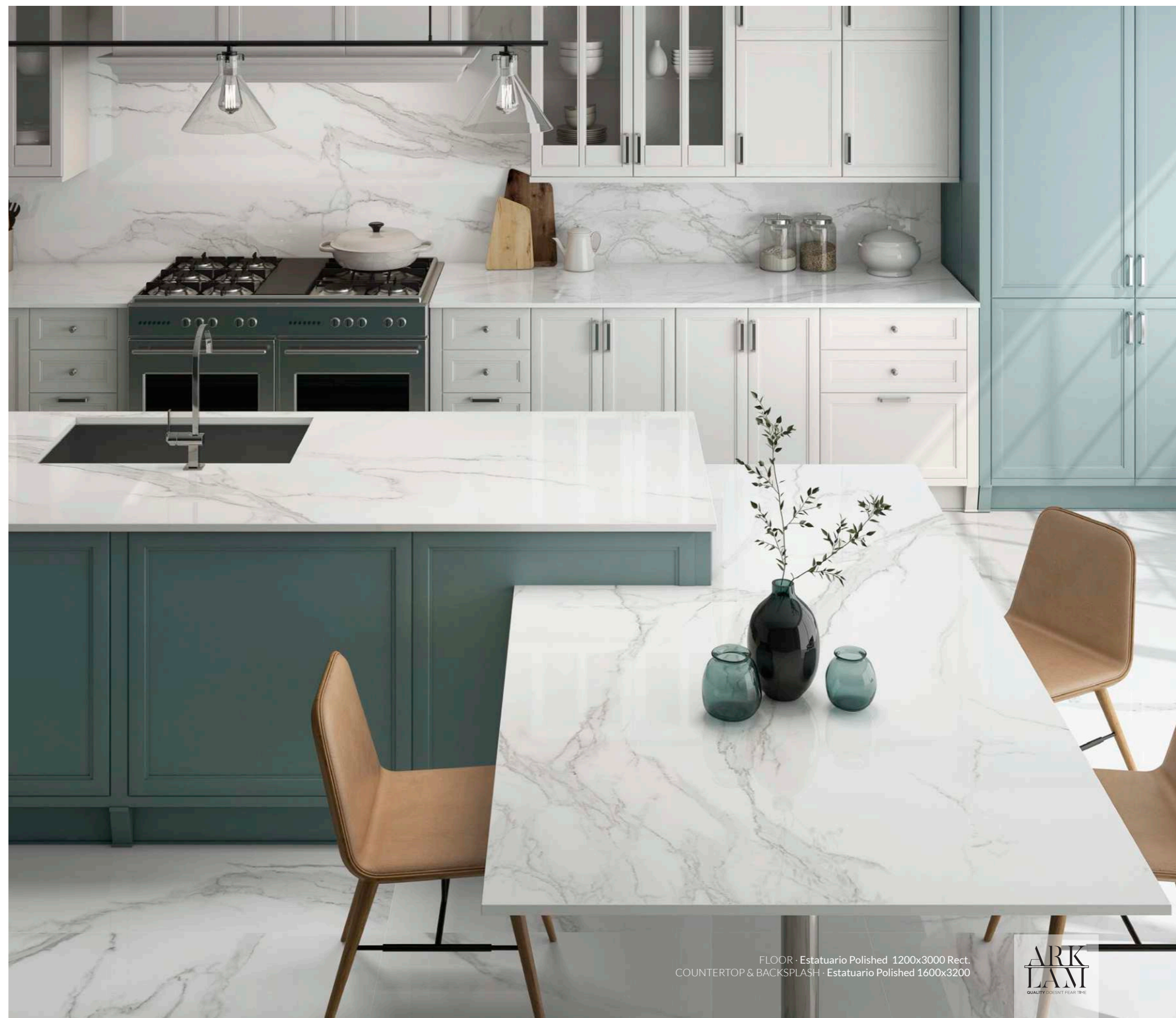
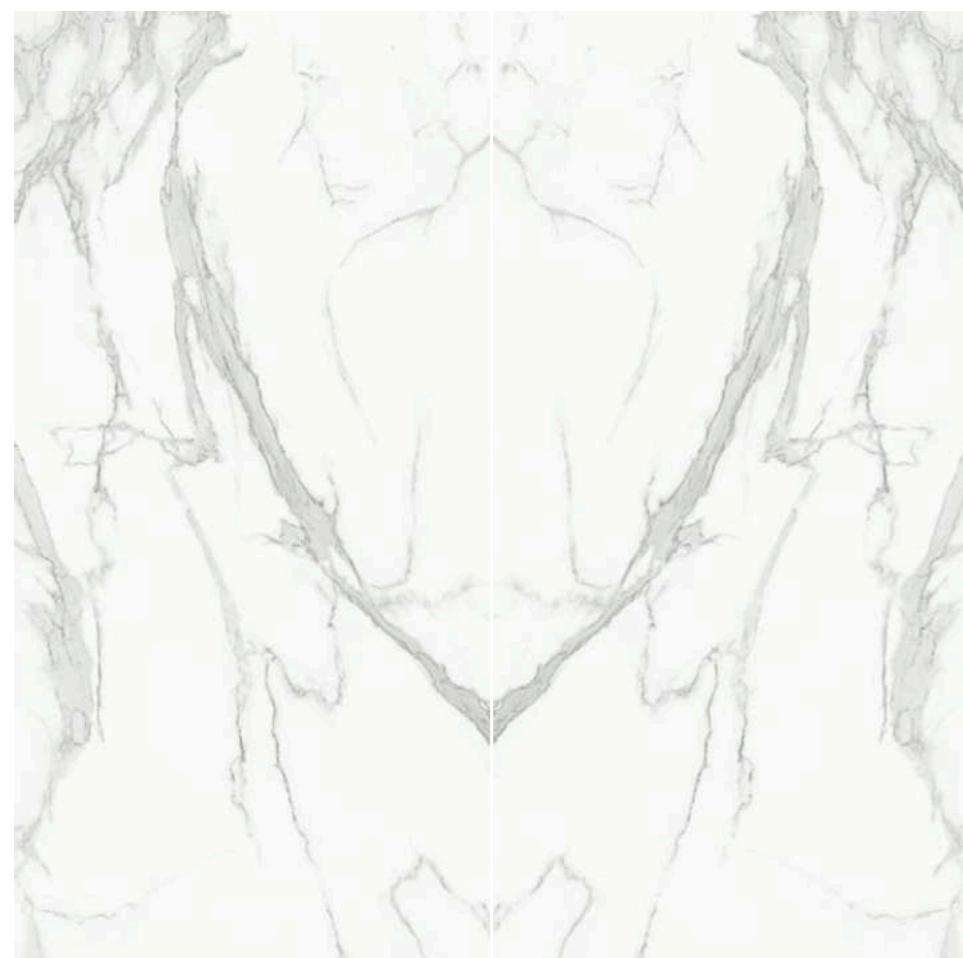

FLOOR · Estatuorio Polished 1200x3000 Rect.
 COUNTERTOP & BACKSPLASH · Estatuorio Polished 1600x3200



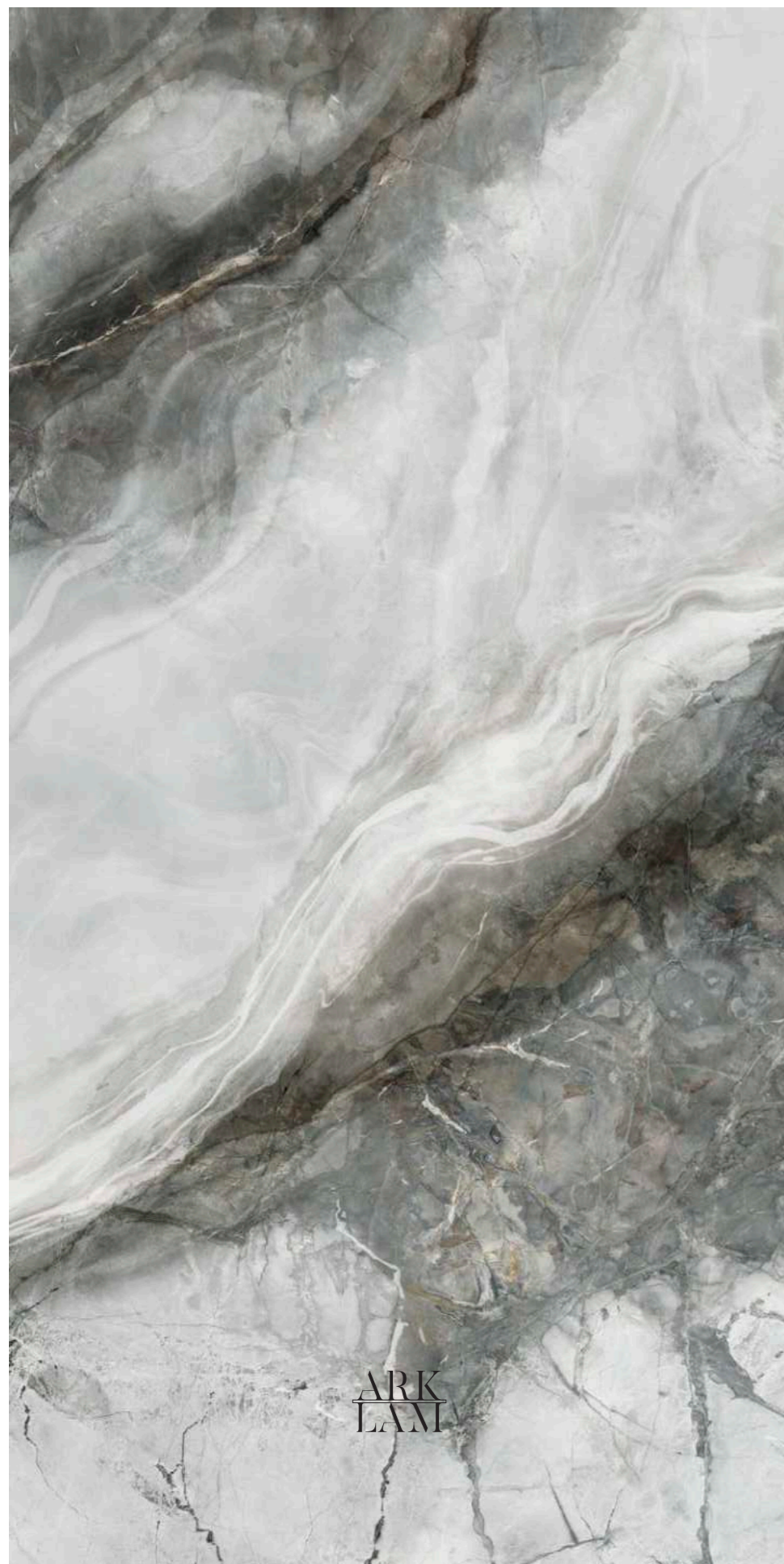

ARK
LAMI

INVISIBLE GREY

▼
12 mm
▲

POLISHED / HOND

1600x3200 mm/ 63"x126"

Invisible Grey Polished 1600x3200

Invisible Grey Hond 1600x3200

1 SINGLE DESIGN / 1 ÚNICO DISEÑO



COUNTERTOP · Invisible Grey Polished 1600x3200
FLOOR · Brazil Super White Hond 1200x3000 Rect.



ARK
LAMI

L I L A C

▼
6 mm

▲
POLISHED

1200x3000 mm/ 47,2"x118"
Lilac Polished 1200x3000 Rect.

4 DESIGNS / 4 DISEÑOS

▼
12&20 mm

▲
HOND

1600x3200 mm/ 63"x126"
Lilac Hond 1600x3200

1 SINGLE DESIGN / 1 ÚNICO DISEÑO



COUNTERTOP · Lilac Hond 1600x3200



COUNTERTOP - Lilac Hond 1600x3200
WALL & FLOOR - Lilac Polished 1200x3000 Rect.

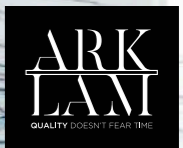



ARK
LAMI

MELBOURNE

▼
6 mm

▲
HOND

1200x3000 mm/ 47,2"x118"
Melbourne Hond 1200x3000 Rect.

4 DESIGNS / 4 DISEÑOS

▼
12 mm

▲
HOND

1600x3200 mm/ 63"x126"
Melbourne Hond 1600x3200

1 SINGLE DESIGN / 1 ÚNICO DISEÑO



COUNTERTOP & BACKSPASH · Melbourne Hond 1600x3200
WALL & FLOOR · Melbourne Hond 1200x3000 Rect.



N A T I V A W H I T E

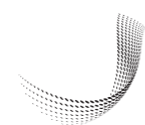

Hypertouch

▼
6 mm

▲
NATURAL

1200x3000 mm / 47,2"x118"
Nativa White Natural 1200x3000 Rect.

3 DESIGNS / 3 DISEÑOS

▼
12 mm

▲
NATURAL

1600x3200 mm / 63"x126"
Nativa White Natural 1600x3200

1 SINGLE DESIGN / 1 ÚNICO DISEÑO

ARK
LAMI



COUNTERTOP & BACKSPLASH · Nativ White Natural 1600x3200
WALL & FLOOR · Nativ White Natural 1200x3000 Rect.



N A T I V A B E I G E

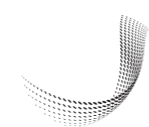

Hypertouch

▼
6 mm

▲
NATURAL

1200x3000 mm/ 47,2"x118"
Nativa Beige Natural 1200x3000 Rect.

3 DESIGNS / 3 DISEÑOS

▼
12 mm

▲
NATURAL

1600x3200 mm/ 63"x126"
Nativa Beige Natural 1600x3200

1 SINGLE DESIGN / 1 ÚNICO DISEÑO

ARK
LAMI



COUNTERTOP · Nativ Beige Natural 1600x3200
FLOOR · Nativ Beige Natural 1200x3000 Rect.



ARK
LAMI

N A T I V A G R E I G E

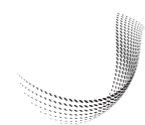

Hypertouch

▼
6 mm

▲
NATURAL

1200x3000 mm/ 47,2"x118"
Nativa Greige Natural 1200x3000 Rect.
3 DESIGNS / 3 DISEÑOS

▼
12 mm

▲
NATURAL

1600x3200 mm/ 63"x126"
Nativa Greige Natural 1600x3200
1 SINGLE DESIGN / 1 ÚNICO DISEÑO



COUNTERTOP · Nativa Greige Natural 1600x3200



COUNTERTOP & BACKSPLASH · Nativa Greige Natural 1600x3200
WALL & FLOOR · Nativa Greige Natural 1200x3000 Rect.



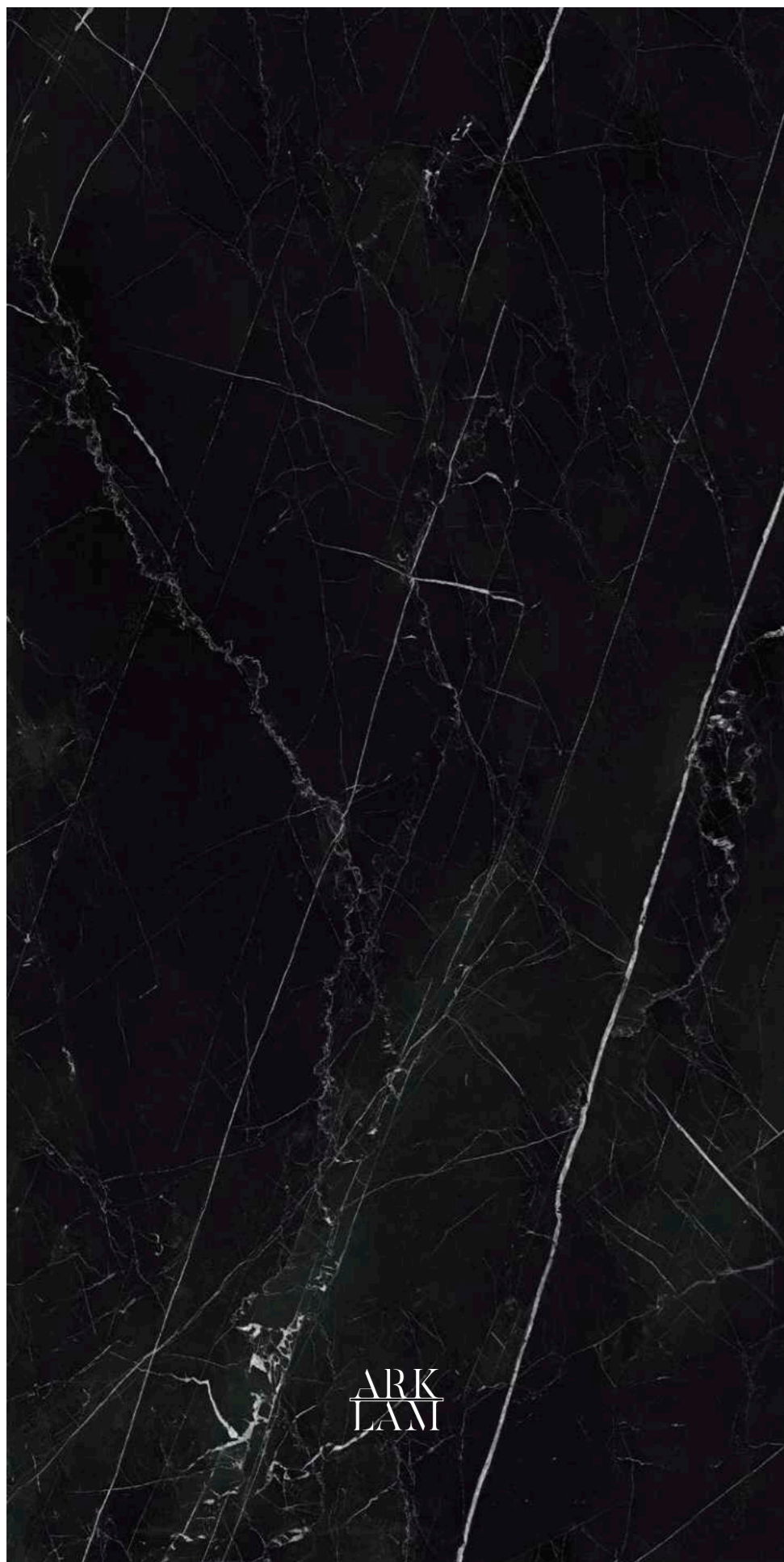

ARK
LAMI

NEGRO MARQUINA

▼
6 mm

▲
POLISHED / SILK

1200x3000 mm/ 47,2"x118"
Negro Marquina Polished 1200x3000 Rect.
Negro Marquina Silk 1200x3000 Rect.

1000x3000 mm/ 39,4"x118"
Negro Marquina Silk 1000x3000 Rect.

4 DESIGNS / 4 DISEÑOS

▼
12 mm

▲
POLISHED / SILK

Negro Marquina Polished 1600x3200
Negro Marquina Silk 1600x3200

1 SINGLE DESIGN / 1 ÚNICO DISEÑO



COUNTERTOP & BACKSPLASH · Negro Marquina Silk 1600x3200
FLOOR · Atlantis Polished 1200x3000 Rect.

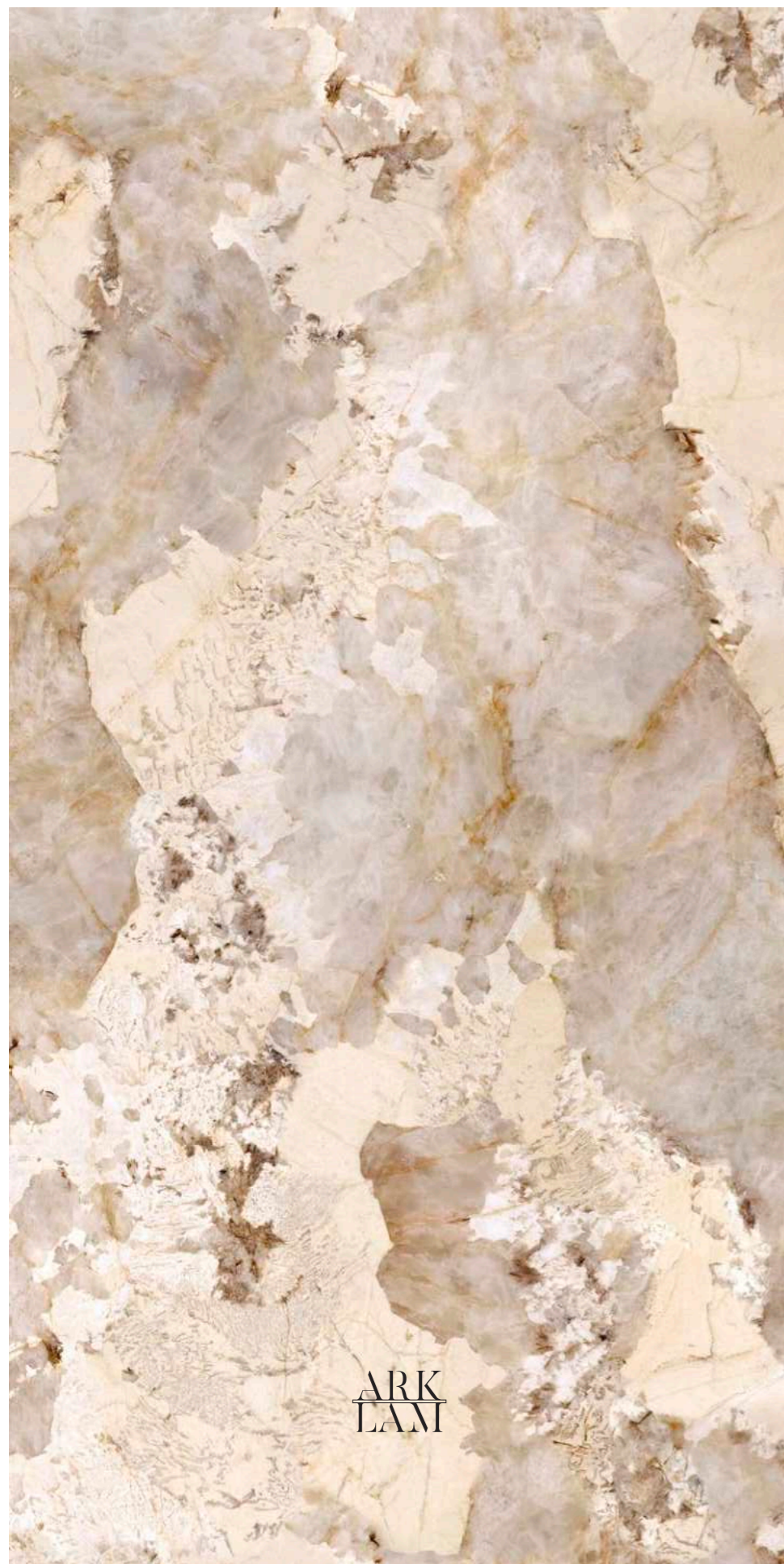

PATAGONIA GOLD

INNOVATIVE SOLUTIONS*

BACKLIGHT EFFECT

TRANSLUCENT CERAMICS

*The backlight effect is only available in the polished finish.
For more information, please contact the sales department.
*El efecto translúcido solo está disponible en el acabado pulido.
Para más información consultar con el departamento comercial.

▼
6 mm
▲

POLISHED / CASHMERE

1200x3000 mm/ 47,2"x118"
Patagonia Gold Polished BL 1200x3000 Rect.
Patagonia Gold Cashmere 1200x3000 Rect.

3 DESIGNS / 3 DISEÑOS

▼
12 mm
▲

CASHMERE

1600x3200 mm/ 63"x126"
Patagonia Gold Cashmere 1600x3200

1 SINGLE DESIGN / 1 ÚNICO DISEÑO

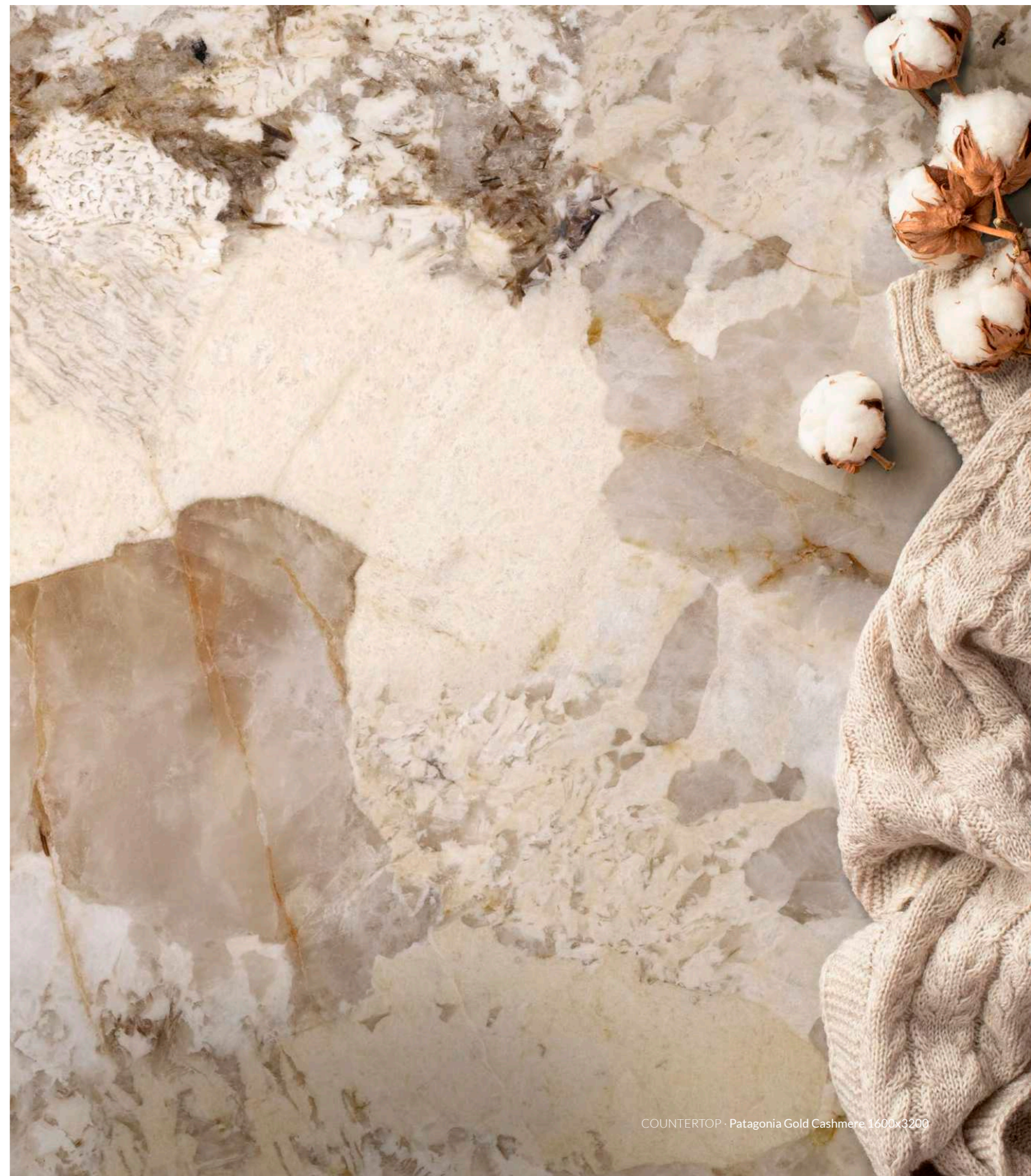

COUNTERTOP · Patagonia Gold Cashmere 1600x3200



COUNTERTOP & FURNITURE - Patagonia Gold Cashmere 1600x3200
WALL - Seven Hazelnut Natural 1200x2800 Rect.
FLOOR - Patagonia Gold Cashmere 1200x3000 Rect. / Mallorca Natural Grip 23x120





P U L P I S N A T U R A L

▼
6 mm
▲

SILK

1200x3000 mm/ 47,2"x118"
Pulpis Natural Silk 1200x3000 Rect.

1000x3000 mm/ 39,4"x118"
Pulpis Natural Silk 1000x3000 Rect.

4 DESIGNS / 4 DISEÑOS

▼
12 mm
▲

SILK

1600x3200 mm/ 63"x126"
Pulpis Natural Silk 1600x3200

1 SINGLE DESIGN / 1 ÚNICO DISEÑO

ARK
LAMI



COUNTERTOP & BACKSPLASH · Pulpis Natural Silk 1600x3200



ROSA PERSIA

▼
6 mm

▲
POLISHED / HOND

1200x3000 mm/ 47,2"x118"
Rosa Persia Polished 1200x3000 Rect.
Rosa Persia Hond 1200x3000 Rect.

4 DESIGNS / 4 DISEÑOS

▼
12 mm

▲
HOND

1600x3200 mm/ 63"x126"
Rosa Persia Hond 1600x3200

1 SINGLE DESIGN / 1 ÚNICO DISEÑO

ARK
LAMI



FLOOR & BACKSPLASH · Rosa Persia Hond 1200x3000 Rect.
COUNTERTOP · Rosa Persia Hond 1600x3200



COUNTERTOP & BACKSPLASH · Rosa Persia Hond 1600x3200
FLOOR · Pure Black Silk 1200x3000 Rect.

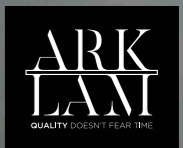



S A H A R A N O I R

ARK
LAMI

▼
6 mm
▲

POLISHED / SILK

1200x3000 mm/ 47,2"x118"
Sahara Noir Polished 1200x3000 Rect.
Sahara Noir Silk 1200x3000 Rect.

4 DESIGNS / 4 DISEÑOS

▼
12 mm
▲

HOND

1600x3200 mm/ 63"x126"
Sahara Noir Hond 1600x3200

1 SINGLE DESIGN / 1 ÚNICO DISEÑO



COUNTERTOP & BACKSPLASH · Sahara Noir Hond 1600x3200
FLOOR · Montreal Natural Matt 20x120 Rect.



ARK
LAMI

S A I N T L A U R E N T

▼
6 mm

▲
NATURAL

1200x3000 mm/ 47,2"x118"
Saint Laurent Natural 1200x3000 Rect.

3 DESIGNS / 3 DISEÑOS

▼
12&20 mm

▲
NATURAL

1600x3200 mm/ 63"x126"
Saint Laurent Natural 1600x3200

2 DESIGNS / 2 DISEÑOS

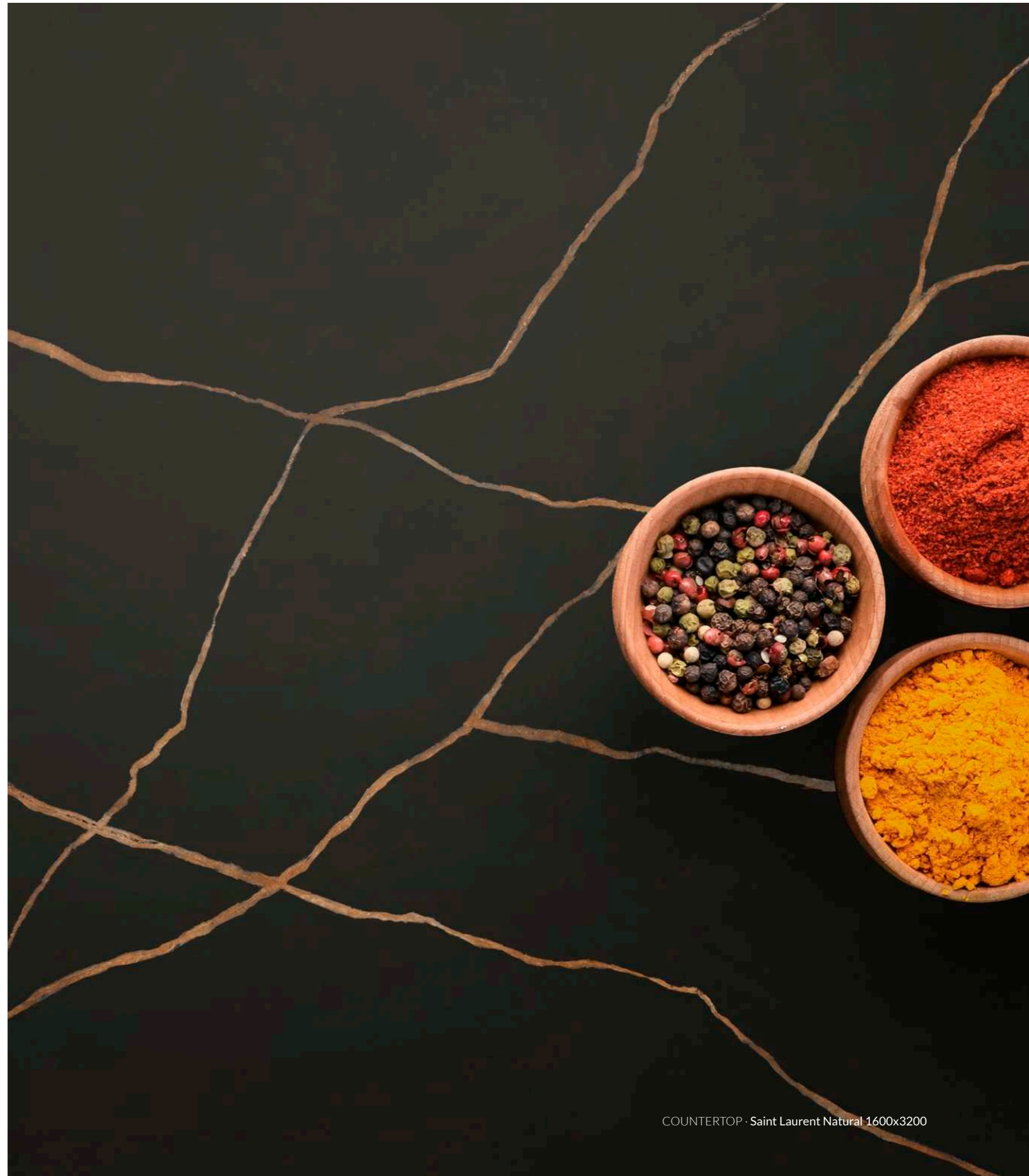

COUNTERTOP · Saint Laurent Natural 1600x3200

SAINT LAURENT

OPENBOOK

- The pieces reflect each other as if they were an open book.
When purchasing two graphics, different models will always be received, forming an Openbook.
Las piezas se reflejan entre sí como si fueran un libro abierto.
Al adquirir dos gráficas, siempre se recibirán modelos diferentes que forman Openbook.

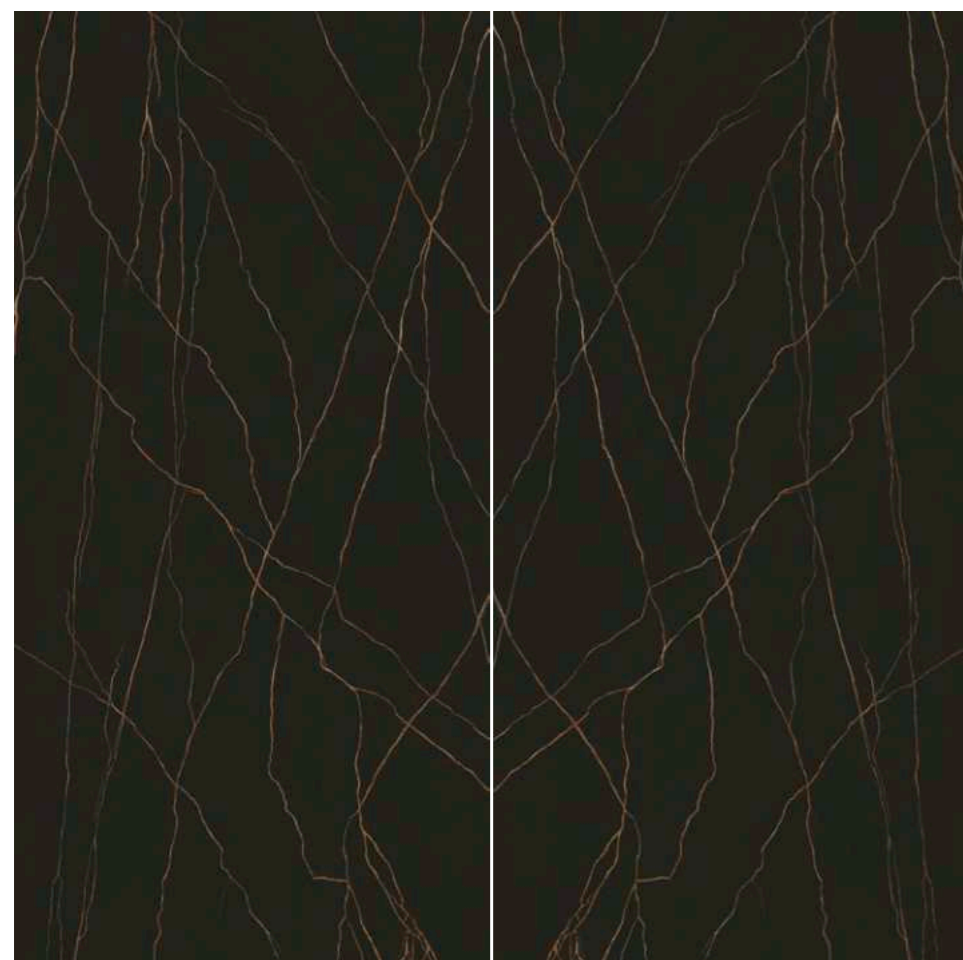

COUNTERTOP & BACKSPLASH · Saint Laurent Natural 1600x3200
FLOOR · Alabama Walnut Matt 59,5x119,2 Rect.





S Y R A C

ARK
LAMI

▼
6 mm

▲

POLISHED / HOND

1200x3000 mm/ 47,2"x118"
Syrac Polished 1200x3000 Rect.
Syrac Hond 1200x3000 Rect.

4 DESIGNS / 4 DISEÑOS

▼
12&20 mm

▲

HOND

1600x3200 mm/ 63"x126"
Syrac Hond 1600x3200

1 SINGLE DESIGN / 1 ÚNICO DISEÑO



COUNTERTOP · Syrac Hond 1600x3200



COUNTERTOP & BACKSPLASH · Syrac Hond 1600x3200
FLOOR · Syrac Hond 1200x3000 Rect.



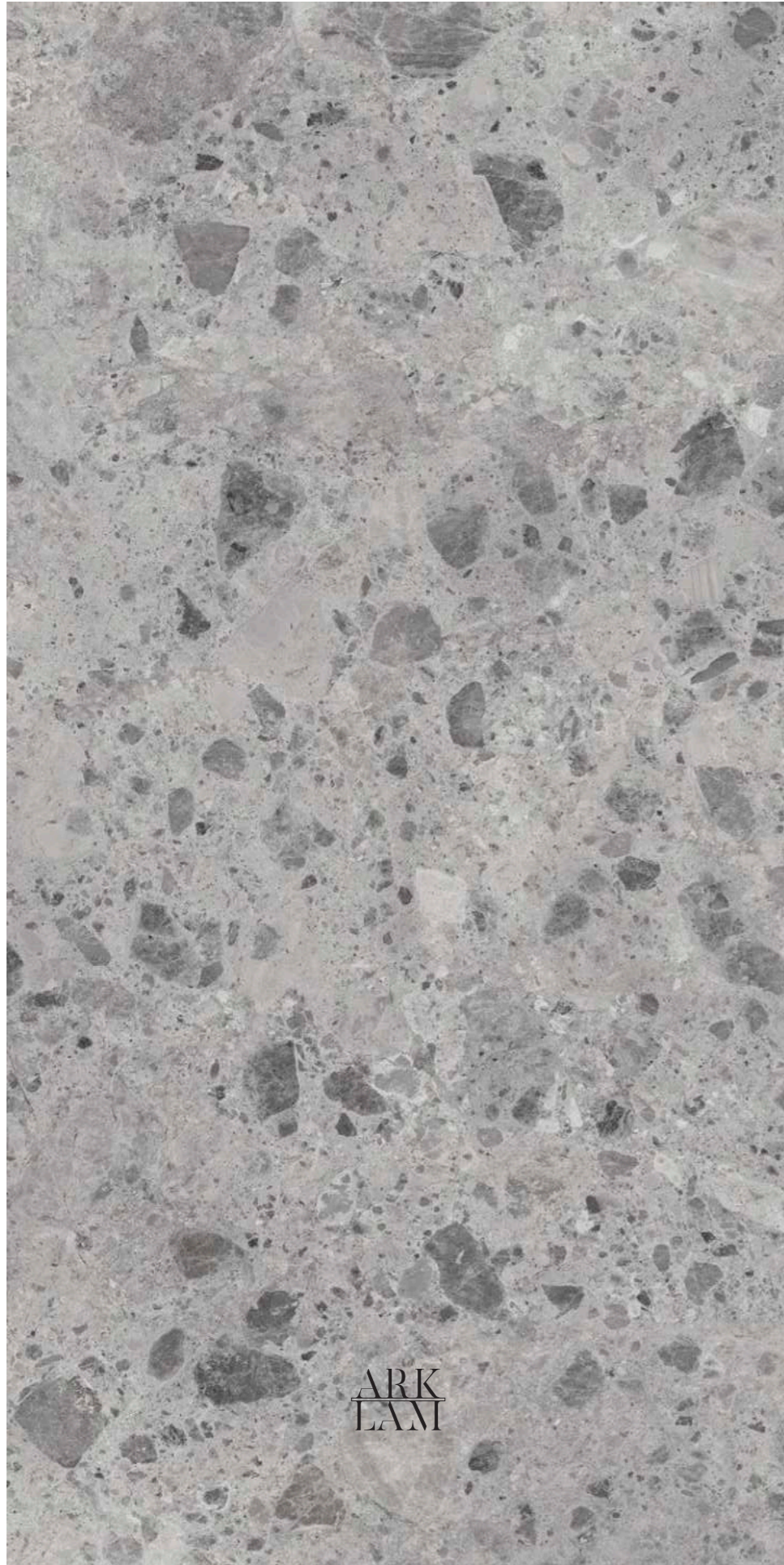

ARK
LAMI

A M S T E R D A M G R E Y

12 mm

NATURAL

1600x3200 mm/ 63"x126"

Amsterdam Grey Natural 1600x3200

1 SINGLE DESIGN / 1 ÚNICO DISEÑO



COUNTERTOP & BACKSPLASH · Amsterdam Grey Natural 1600x3200
FLOOR · Londra Black Silk 1200x3000 Rect.



FLOOR - Seven Silver Natural 1200x2800 Rect.
BACKSPLASH & COUNTERTOP - Amsterdam Grey Natural 1600x3200

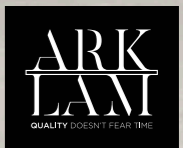



BASALT GREY

ARK
LAMI

12 mm

SILK

1600x3200 mm/ 63"x126"
Basalt Grey Silk 1600x3200

1 SINGLE DESIGN / 1 ÚNICO DISEÑO



WALL - Syrac Hond 1200x3000 Rect.
COUNTERTOP - Basalt Grey Silk 1600x3200
FLOOR - Bateig Blue Natural 1200x3000 Rect.



B A T E I G B L U E

ARK
LAMI

▼
6 mm

▲
NATURAL

1200x3000 mm/ 47,2"x118"
Bateig Blue Natural 1200x3000 Rect.

3 DESIGNS / 3 DISEÑOS

▼
12 mm

▲
NATURAL

1600x3200 mm/ 63"x126"
Bateig Blue Natural 1600x3200

1 SINGLE DESIGN / 1 ÚNICO DISEÑO



COUNTERTOP · Bateig Blue Natural 1600x3200



COUNTERTOP & BACKSPLASH · Bateig Blue Natural 1600x3200
FLOOR · Bateig Blue Natural 1200x3000 Rect.



ARK
LAMI

BATEIG VERONA

▼
6 mm

▲
NATURAL

1200x3000 mm/ 47,2"x118"
Bateig Verona Natural 1200x3000 Rect.
3 DESIGNS / 3 DISEÑOS

▼
12 mm

▲
NATURAL

1600x3200 mm/ 63"x126"
Bateig Verona Natural 1600x3200
1 SINGLE DESIGN / 1 ÚNICO DISEÑO



COUNTERTOP - Bateig Verona Natural 1600x3200



COUNTERTOP & BACKSPLASH - Bateig Verona Natural 1600x3200
FLOOR - Bateig Verona Natural 1200x3000 Rect.





GRIS LEVANTE

ARK
LAMI

▼
6 mm

▲
NATURAL

1200x3000 mm/ 47,2"x118"
Gris Levante Natural 1200x3000 Rect.
3 DESIGNS / 3 DISEÑOS

▼
12 mm

▲
NATURAL

1600x3200 mm/ 63"x126"
Gris Levante Natural 1600x3200
1 SINGLE DESIGN / 1 ÚNICO DISEÑO



COUNTERTOP & BACKSPLASH - Gris Levante Natural 1600x3200
FLOOR - Alabama Line Natural Matt 20x120 Rect.



MANHATTAN GREY

ARK
LAMI

▼
6 mm

▲
SILK

1200x3000 mm/ 47,2"x118"
Manhattan Grey Silk 1200x3000 Rect.

1000x3000 mm/ 39,4"x118"
Manhattan Grey Silk 1000x3000 Rect.

8 DESIGNS / 8 DISEÑOS

▼
12 mm

▲
SILK

1600x3200 mm/ 63"x126"
Manhattan Grey Silk 1600x3200

1 SINGLE DESIGN / 1 ÚNICO DISEÑO



COUNTERTOP - Manhattan Grey Silk 1600x3200



M I R A G E G R E Y

ARK
LAMI

12 mm

BUSH HAMMERED

1600x3200 mm/ 63"x126"

Mirage Grey Bush Hammered 1600x3200

1 SINGLE DESIGN / 1 ÚNICO DISEÑO



COUNTERTOP · Mirage Grey Bush Hammered 1600x3200



BACKSPLASH & COUNTERTOP · Mirage Grey Bush Hammered 1600x3200
FLOOR · Pandora Silk 1000x3000 Rect.



SEVEN HAZELNUT

▼
6 mm
▲

NATURAL

1200x2800 mm / 47,2"x110"
Seven Hazelnut Natural 1200x2800 Rect.

5 DESIGNS / 5 DISEÑOS

▼
12 mm
▲

NATURAL

1600x3200 mm / 63"x126"
Seven Hazelnut Natural 1600x3200

1 SINGLE DESIGN / 1 ÚNICO DISEÑO

ARK
LAMI



FURNITURE - Saint Laurent Natural 1200x3000 Rect.
COUNTERTOP & BACKSPLASH - Seven Hazelnut Natural 1600x3200
WALL & FLOOR - Seven Hazelnut Natural 1200x2800 Rect.



ARK
LAMI

TUNDRA CREAM

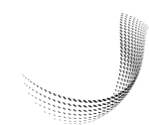

Hypertouch

▼
6 mm

▲
NATURAL

1200x3000 mm/ 47,2"x118"
Tundra Cream Natural 1200x3000 Rect.

3 DESIGNS / 3 DISEÑOS

▼
12 mm

▲
NATURAL

1600x3200 mm/ 63"x126"
Tundra Cream Natural 1600x3200

1 SINGLE DESIGN / 1 ÚNICO DISEÑO

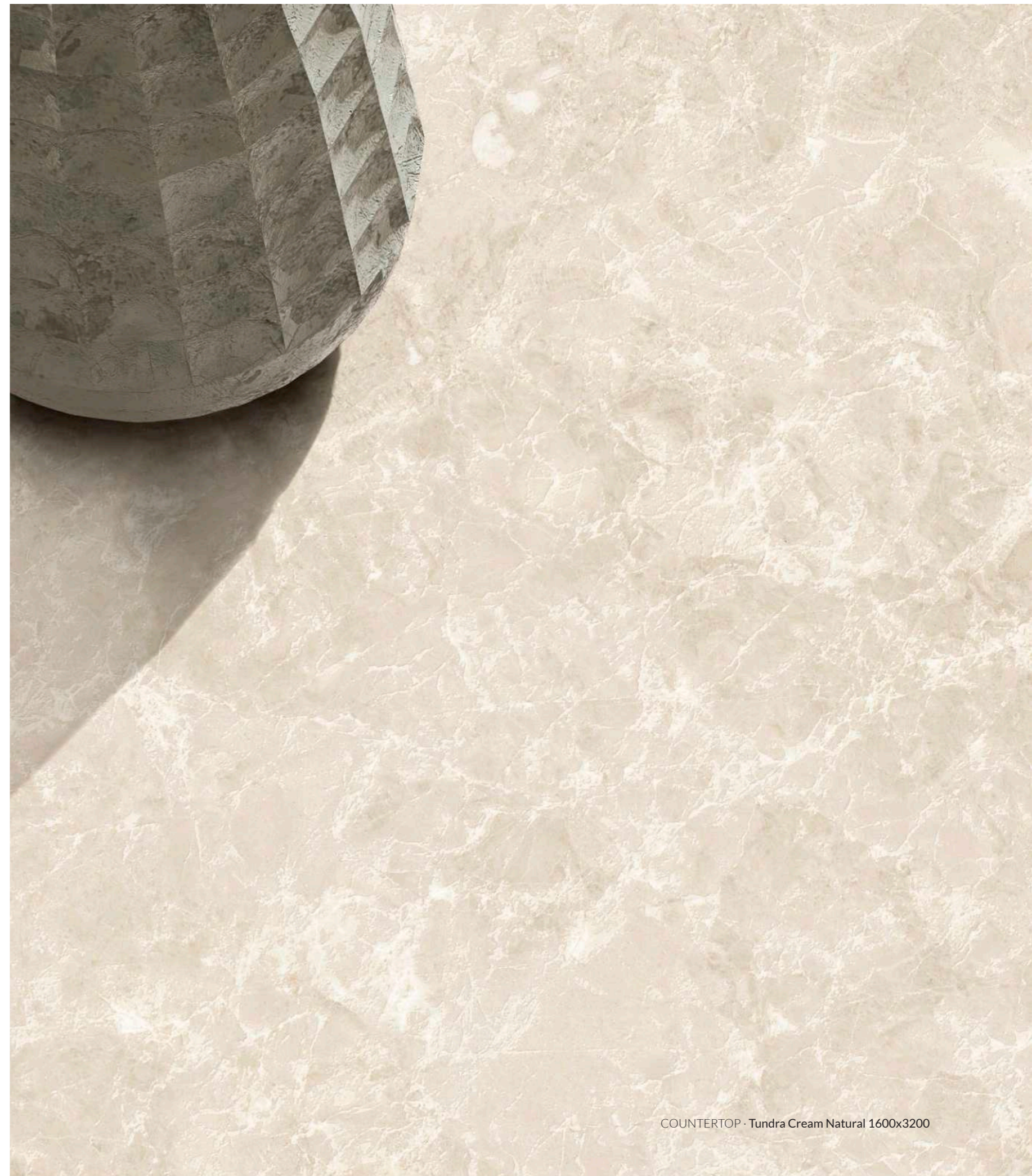

COUNTERTOP · Tundra Cream Natural 1600x3200



ARK
LAMI

TUNDRA GREIGE

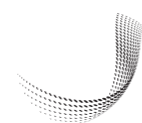

Hypertouch

▼
6 mm

▲
NATURAL

1200x3000 mm/ 47,2"x118"
Tundra Greige Natural 1200x3000 Rect.
3 DESIGNS / 3 DISEÑOS

▼
12 mm

▲
NATURAL

1600x3200 mm/ 63"x126"
Tundra Greige Natural 1600x3200
1 SINGLE DESIGN / 1 ÚNICO DISEÑO



COUNTERTOP · Tundra Greige Natural 1600x3200



WALL & FLOOR · Tundra Greige Natural 1200x3000 Rect.
COUNTERTOP & BACKSPLASH · Tundra Greige Natural 1600x3200





VULCANO

ARK
LAMI

▼
20 mm
▲
SILK

1600x3200 mm/ 63"x126"
Vulcano Silk 1600x3200

1 SINGLE DESIGN / 1 ÚNICO DISEÑO



COUNTERTOP · Vulcano Silk 1600x3200
FLOOR · Avenue White Silk 1200x3000 Rect.



ARCANE

ARK
LAM

12 mm

NATURAL

1600x3200 mm/ 63"x126"

Arcane Camel Natural 1600x3200

1 SINGLE DESIGN / 1 ÚNICO DISEÑO



COUNTERTOP · Arcane Camel Natural 1600x3200
FURNITURE · Pure Black Silk 1200x3000 Rect.
WALL · Seven Silver Natural 1200x2800 Rect.



BACKSPLASH · Syrac Hond 1200x3000 Rect.
COUNTERTOP · Arcane Camel Natural 1600x3200 / Syrac Hond 1600x3200
FLOOR · Syrac Hond 1200x3000 Rect.





ARK
LAMI

CANADA

12 mm

SILK

1600x3200 mm/ 63"x126"
Canada Silk 1600x3200

1 SINGLE DESIGN / 1 ÚNICO DISEÑO



COUNTERTOP - Canada Silk 1600x3200
WALL - Calacatta Gold Hond 1200x3000 Rect.

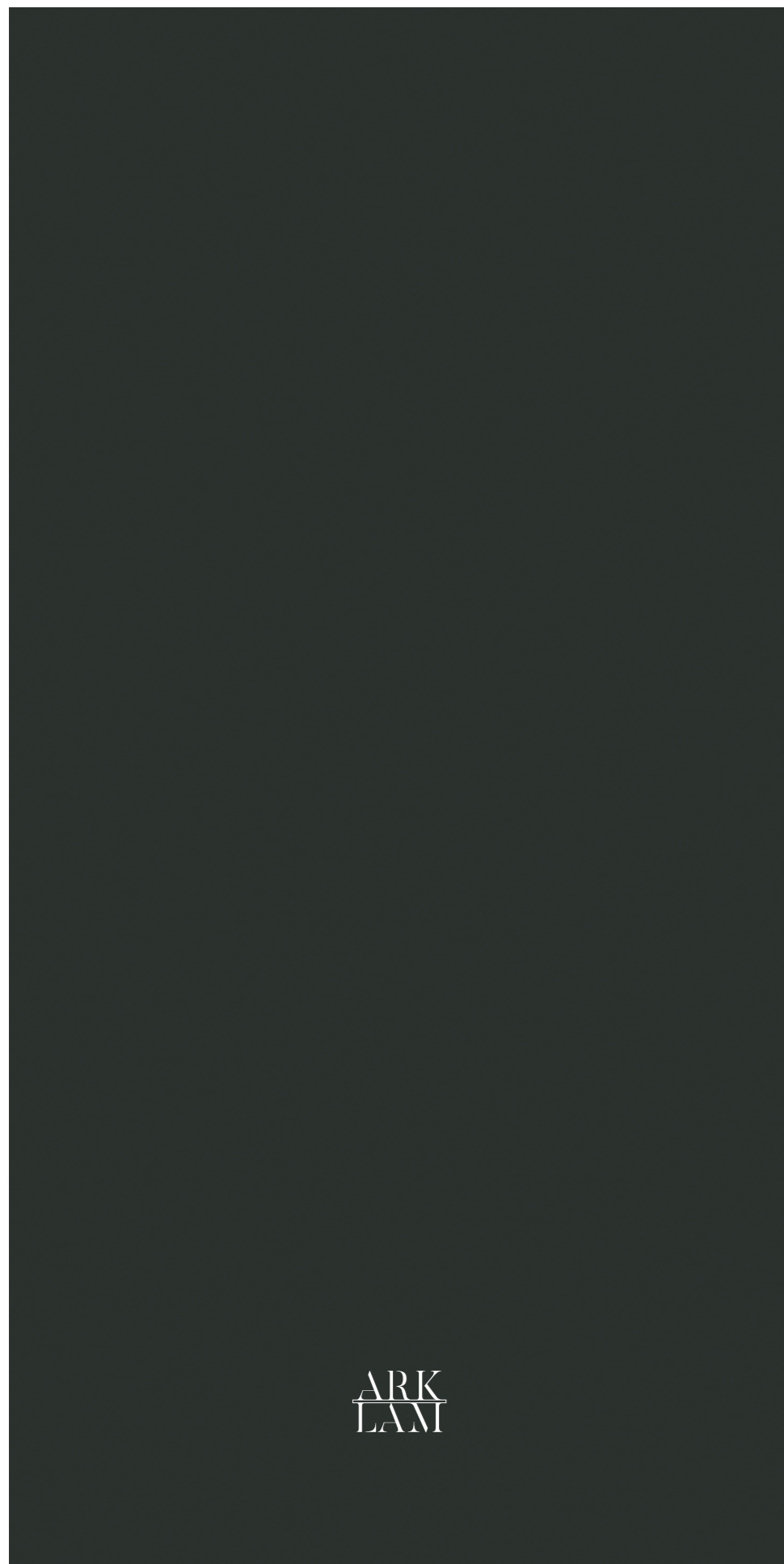

PURE BLACK

ARK
LAMI

▼
6 mm

▲
SILK

1200x3000 mm/ 47,2"x118"
Pure Black Silk 1200x3000 Rect.

▼
12&20 mm

▲
HOND

1600x3200 mm/ 63"x126"
Pure Black Hond 1600x3200



COUNTERTOP · Pure Black Hond 1600x3200
FLOOR · Atrium Grey Natural 1200x3000 Rect.



PURE GREY

ARK
LAMI

20 mm

HOND

1600x3200 mm/ 63"x126"
Pure Grey Hond 1600x3200



COUNTERTOP & BACKSPLASH · Pure Grey Hond 1600x3200
FLOOR · Portobello Polished 1200x3000 Rect.

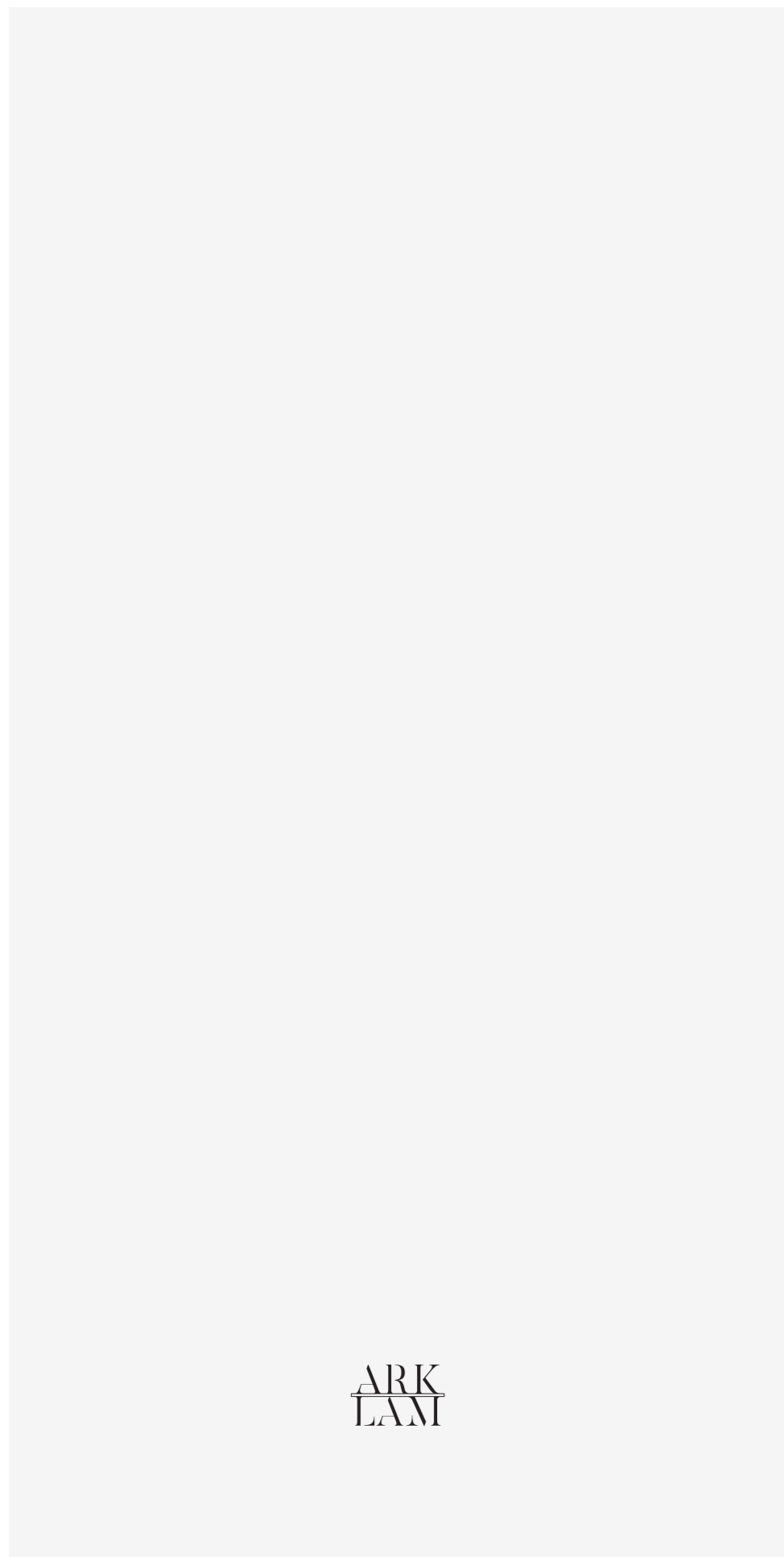

ARK
LAMI

PURE SUPER WHITE

12&20 mm

HOND

1600x3200 mm/ 63"x126"
Pure Super White Hond 1600x3200



COUNTERTOP & BACKSPLASH · Pure Super White Hond 1600x3200
FLOOR · Atrium Grey Natural 1200x3000 Rect.



PACKING

EMBALAJE

PIECES / PIEZAS









| FORMAT FORMATO | THICKNESS FORMATO | M2 | KG |
|--------------------|----------------------|------|-----|
| 1600x3200 63"x126" | 12 MM | 5,12 | 160 |
| 1600x3200 63"x126" | 20 MM | 5,12 | 258 |

PALET/FRAME PALLET/CABALLETE

| FORMAT FORMATO | THICKNESS FORMATO | PIECES PIEZAS | M2 | NET WEIGHT PESO NETO (Kg) | GROSS WEIGHT PESO BRUTO (Kg) | PALET / PALLET | | |
|-----------------------|----------------------|------------------|--------|---------------------------------|------------------------------------|----------------|-----------------|----------------|
| | | | | | | HEIGHT ALTO | LENGHT LARGO | WIDTH ANCHO |
| 1600x3200 63"x126" | 12 MM | 22 | 112,64 | 3.520 | 3.730 | 2.000 | 3.300 | 750 |
| 1600x3200 63"x126" | 20 MM | 12 | 61,44 | 3.096 | 3.310 | 2.000 | 3.300 | 750 |











PROPERTIES

PROPIEDADES

| | | | |
|---|---|---|--|
|  | Highly UV Resistant Resistente a los rayos UV |  | Resistant to stains Resistente a las manchas |
|  | Frost resistance Resistente a las heladas |  | Resistant to scratches Resistencia al rayado |
|  | Waterproof Impermeable |  | Easy to clean Fácil de limpiar |
|  | Resistance to high temperatures Resistente a altas temperaturas |  | Recyclable Reciclable |

TREATMENT OF EDGES

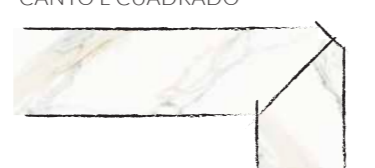
TRATAMIENTO DE CANTOS

| | |
|--|---|
| <p>45° ANGLE SQUARE EDGE CANTO CUADRADO A 45°</p>  | <p>45° ANGLE ROUNDED EDGE CANTO REDONDEADO A 45°</p>  |
| <p>STRAIGHT SQUARE EDGE CANTO CUADRADO RECTO</p>  | <p>STRAIGHT ROUNDED EDGE CANTO REDONDEADO RECTO</p>  |
| <p>DOUBLE STRAIGHT SQUARE EDGE DOBLE CANTO CUADRADO RECTO</p>  | <p>DOUBLE STRAIGHT ROUNDED EDGE DOBLE CANTO REDONDEADO RECTO</p>  |
| <p>ROUNDED EDGE CANTO REDONDEADO</p>  | <p>SQUARE ROUNDED EDGE CANTO REDONDEADO ESCUADRA</p>  |
| <p>L-SHAPED SQUARE EDGE CANTO L CUADRADO</p>  | <p>L-SHAPED ROUNDED EDGE CANTO L REDONDEADO</p>  |

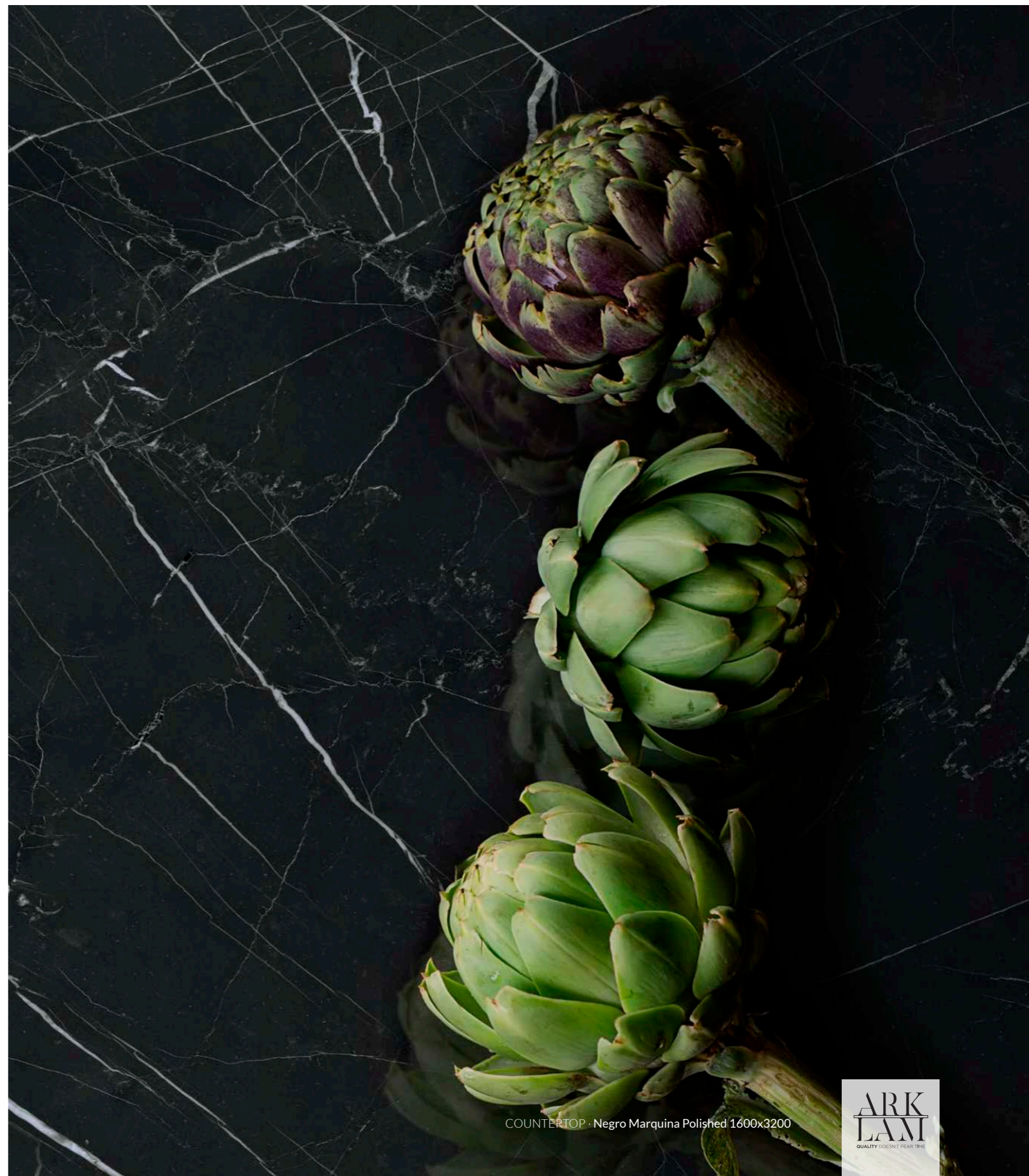

COUNTERTOP : Negro Marquina Polished 1600x3200



CLEANING

LIMPIEZA

For optimal maintenance of Arklam Countertops, regular cleaning with a **rag moistened with soap and water** is recommended. In addition, it is advisable to clean stains as soon as they are produced and not to let them dry out. If the stain is not recent and has become embedded, warm soapy water should be applied for a few minutes to soften the dirt and then removed with a damp rag.

As for the material used to remove the stains, we recommend **soft rags and blue anti-scratch pads**. The more respectful the material used for cleaning, the better the maintenance of the worktop.

Abrasive products or bleach should be avoided at all times. If the latter is used, it should be lowered with water and not left to act on the Arklam surface for a long time. It is important to pay special attention to the polished finish as it is more sensitive to abrasive products than other finishes.

Although Arklam's sintered mass is fire and heat resistant, whenever possible, a **protector should be used to support hot pots or pans**. It is also important to use cutting boards to avoid cuts and knocks on the worktop as much as possible, especially when using ceramic knives and instruments.

Arklam Countertops is a material with a high resistance to shocks, scratches, heat and chemicals. But it is always important to take care of the material, protecting it as much as possible as you would any other type of countertop.

Para un mantenimiento óptimo de Arklam Countertops, se recomienda una limpieza habitual con un **pañó húmedo con agua y jabón**. Además, es recomendable limpiar las manchas en el momento en el que se producen y no dejar que se sequen. En caso de que la mancha no sea reciente y se haya incrustado, hay que poner agua tibia con jabón durante unos minutos para que la suciedad se ablande y después retirar con un paño húmedo.

En cuanto al material empleado para retirar las manchas, se recomienda que sean **paños suaves y estropajos azules anti-rayaduras**. Cuanto más respetuoso sea el material utilizado para limpiar, mejor será el mantenimiento de la encimera.

Se deben evitar en todo momento productos abrasivos o lejías. En el caso de utilizar esta última, se deberá rebajar con agua y no dejar actuar durante mucho rato sobre la superficie Arklam. Es importante prestar especial atención al acabado pulido puesto que es más sensible a los productos abrasivos que otros acabados.

Aunque la masa sinterizada de Arklam es resistente al fuego y al calor, **siempre que sea posible se utilizará un protector para apoyar las ollas o sartenes calientes**. También es importante el uso de tablas de cortar para evitar en la medida de lo posible los cortes y los golpes sobre la encimera, sobretodo en el caso de utilizar cuchillos e instrumentos de cerámica.

Arklam Countertops es un material con una alta resistencia a los golpes, al rayado, al calor y a los químicos. Pero siempre es importante cuidar el material, protegiéndolo lo máximo posible igual que se haría con cualquier otro tipo de encimera.

 VERY IMPORTANT/ MUY IMPORTANTE

BACTERICIDAL EFFECT
EFICACIA BACTERICIDA

During our lifetime, we are constantly exposed to high levels of bacteria. With Arklam your countertops will be hygienic and safe thanks to its anti-fungal and anti-bacterial properties.

Durante nuestras vidas, estamos en contacto permanente con un número muy elevado de bacterias. Con Arklam tus encimeras serán higiénicas y seguras gracias a sus propiedades antibacterianas contra hongos y bacterias.

SELF-CLEANING
EFICACIA AUTOLIMPIANTE

Hidrofilicity - less water needed.

With Arklam, any cleaning tasks become easier and more enjoyable since less quantities of detergents and cleaning products are needed.

Hidrofilia - menor uso.

Con Arklam la limpieza de los restos de suciedad resulta más agradable, debido a su baja necesidad en la utilización de sustancias y productos desinfectivos.

REMOVING STAINS/ LIMPIEZA DE MANCHAS

| TYPE OF STAIN/ TIPO DE MANCHA | STEP 1/ 1ER PASO | STEP 2/ 2º PASO |
|--|--|--------------------|
| CEMENT, LIME SCALE, SCRATCHES BY METAL OBJECTS, OXIDES CEMENTO, CAL DEL AGUA, RAYAS METALES, ÓXIDOS | | Deterdek PRO |
| REMAINS OF EPOXY GROUTING RESIDUOS DE JUNTAS EPOXI | Wash with water as soon as possible and rub the area gently with a cloth. Lavar lo antes posible con agua, frotando suavemente con un paño. | Fila CR10 |
| FAT, GREASE, FOOD, RUBBER, INK, FELT TIP PEN, CANDLE WAX, TREE RESIN, REMAINS OF ADHESIVE TAPE, ETC GRASAS, COMIDAS, GOMA, TINTES, ROTULADOR, CERA DE VELAS, RESINAS ÁRBOLES, RESIDUOS CINTA ADHESIVA, ETC. | | Fila PS/87 PRO |
| GRAFFITI PINTADAS DE GRAFITIS | | Fila Nopaint Star |
| COFFE, TEA, JUICE, SOFT DRINKS CAFÉ, TÉ, ZUMOS, REFRESCOS | | Fila sr/95 |

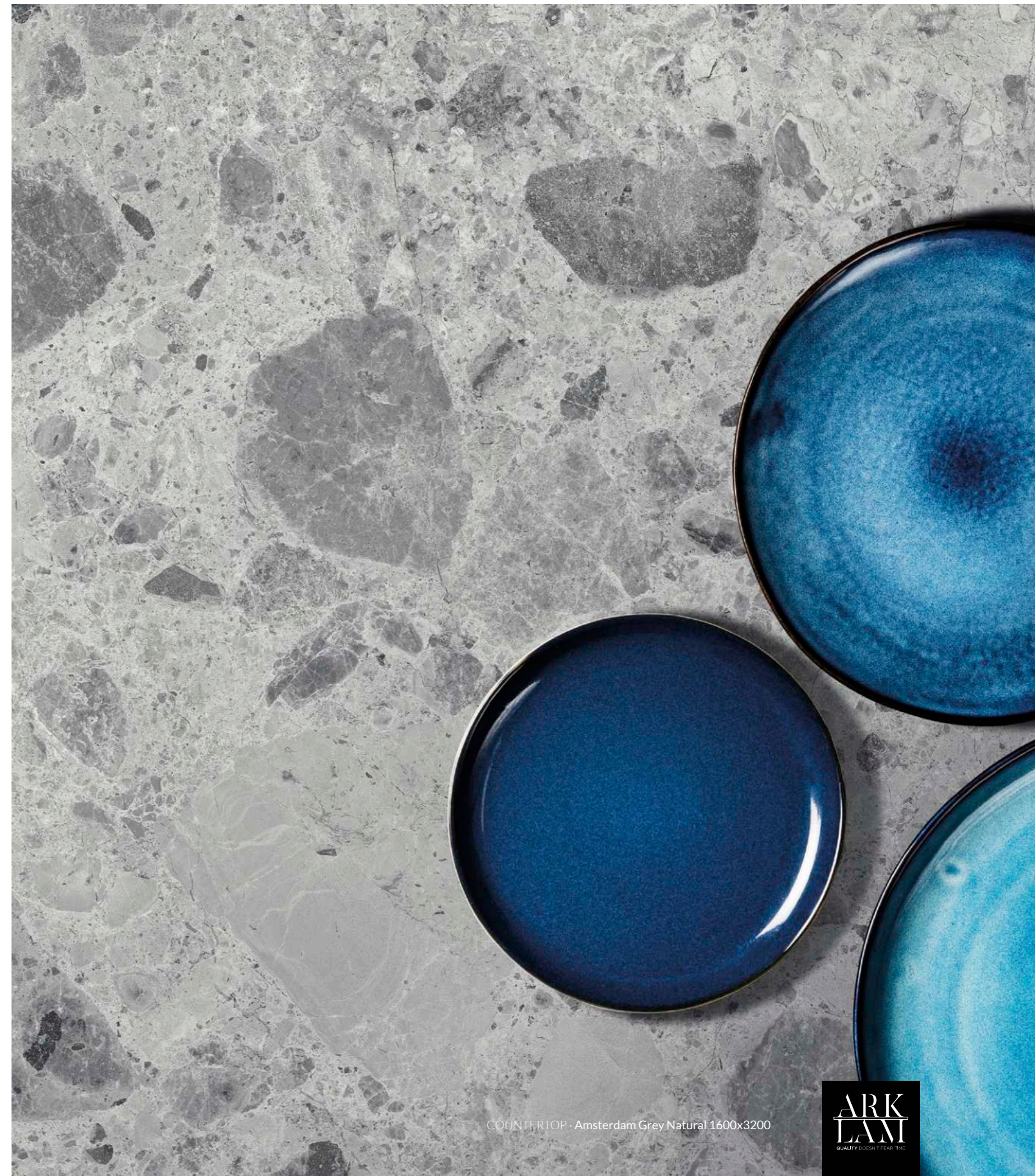

COUNTERTOP - Amsterdam Grey Natural 1600x3200

**ARK
LAMI**
QUALITY DOESN'T FEEL THE

TECHNICAL CHARACTERISTICS

CARACTERÍSTICAS TÉCNICAS

| TECHNICAL CHARACTERISTICS/ CARACTERÍSTICAS TÉCNICAS | REFERENCE STANDARD/ NORMA DE REFERENCIA | VALUE REQUIRED/ VALOR REQUERIDO | MEAN VALUE/ VALOR MEDIO OBTENIDO |
|--|--|------------------------------------|-------------------------------------|
| | | 12&20 MM | |

DIMENSIONAL CHARACTERISTICS / CARACTERÍSTICAS DIMENSIONALES

Permissible deviation from work size.
Desviación admisible respecto de la dimensión de fabricación.

| Length and width/ Longitud y anchura | EN-ISO 10545-2 | ± 0,6 % / ± 2 mm | ± 0,6 % / ± 2 mm |
|---|-------------------|--------------------|--------------------|
| Thickness/ Grosor | | ± 5 % / ± 0,5 mm | ± 5 % / ± 0,5 mm |
| Warpages of edges/ Rectitud de los lados | | ± 0,5 % / ± 1,5 mm | ± 0,5 % / ± 1,5 mm |
| Wedging/ Ortogonalidad | | ± 0,5 % / ± 2 mm | ± 0,5 % / ± 2 mm |
| Flatness/ Planaridad | | ± 0,5 % / ± 2 mm | ± 0,5 % / ± 2 mm |

CHEMICAL CHARACTERISTICS / CARACTERÍSTICAS QUÍMICAS

| | | | |
|---|--------------------|---|--|
| Resistance to household cleaning products and swimming pool additives/ Resistencia a productos domésticos de limpieza y aditivos de piscina. | EN-ISO 10545-13 | GB Min./ Min. GB | Resist (GB)/ Resiste (GB) |
| Resistance to acids and bases in low concentration/ Resistencia a ácidos y bases en baja concentración. | EN-ISO 10545-13 | As indicated by manufacturer/ Indicada por el fabricante | (GLB) Min / Mín (GLB) |
| Resistance to acids and bases in high concentration/ Resistencia a ácidos y bases en alta concentración. | EN-ISO 10545-13 | As indicated by manufacturer/ Indicada por el fabricante | (GHB) Min / Mín (GHB) |
| Resistance to staining/ Resistencia a las manchas | EN-ISO 10545-14 | Class 3 min./ Mín. Clase 3 | Silk Class 5 Polished Class 3-4 Silk Clase 5 Polished clase 3-4 |

| TECHNICAL CHARACTERISTICS/ CARACTERÍSTICAS TÉCNICAS | REFERENCE STANDARD/ NORMA DE REFERENCIA | VALUE REQUIRED / VALOR REQUERIDO | MEAN VALUE/ VALOR MEDIO OBTENIDO |
|--|--|-------------------------------------|-------------------------------------|
| | | 12&20 MM | |

PHYSICAL CHARACTERISTICS / CARACTERÍSTICAS FÍSICAS

| | | | |
|--|--|---|--|
| Water absorption/ Absorción al agua | EN-ISO 10545-3 | ≤ 0,5 % | ≤ 0,5 % |
| Breaking strength/ Fuerza de rotura | EN-ISO 10545-4 | ≥ 1300 N | Standard overtakes/ Supera la norma |
| Bending strength/ Resistencia a la flexión | EN-ISO 10545-4 | ≥ 35 N / mm ² | Standard overtakes/ Supera la norma |
| Resistance to deep abrasion / Resistencia a la abrasión profunda | EN-ISO 10545-6 | ≤ 175 mm ³ | Standard overtakes/ Supera la norma |
| Resistance to abrasion utility - PEI/ Resistencia a la abrasión PEI | EN-ISO 10545-7 | Indicate the result/ Indicar resultado | 1 - 5 |
| Lineal thermal expansion/ Dilatación Térmica lineal | EN-ISO 10545-8 | Indicate the result/ Indicar resultado | ≤ 9 X 10 ⁻⁶ K ⁻¹ |
| Thermal shock resistance/ Resistencia al choque térmico | EN-ISO 10545-9 | Pass test/ Superar prueba | Resist/ Resiste |
| Mohs surface hardness/ Dureza Mohs | EN 101 | Indicate the result/ Indicar resultado | 4 - 8 |
| Frost resistance/ Resistencia a la helada | EN-ISO 10545-12 | Pass test/ Superar prueba | Resist/ Resiste |
| Fire resistance/ Resistencia al fuego | Decision 96/603/CE Modified Decisión 96/603/CE Modificada | Indicate the result/ Indicar resultado | A1 _{fl} |



TECHNICAL CHARACTERISTICS
CARACTERÍSTICAS TÉCNICAS

At Arklam, we are committed to innovation and excellence in designing home solutions that make a difference. After a lengthy research process, we are excited to introduce a true revolution in the world of cooking: our new hidden induction system for countertops.

We love to envision a kitchen free from visual obstructions, where the beauty of the Arklam countertop remains impeccably intact. With our hidden induction system, that vision becomes a reality. It is no longer necessary to sacrifice aesthetics for functionality: now, you can enjoy the best of both worlds.

How it works?

The hidden induction system by Arklam is ingeniously simple, yet incredibly effective. **Designed to integrate seamlessly into our countertops**, this system allows you to cook directly on the Arklam surface without any visible obstacles.

On a completely flat and even surface, you can place your pots and pans directly on the countertop without any visual interruptions. With Arklam's hidden induction technology, energy is transferred directly to your cookware through the countertop, enabling you to cook efficiently and effortlessly.

Discover the magic of cooking without visual limits and immerse yourself in a world of possibilities with Arklam. Experience innovation today and transform your kitchen into a space of unmatched beauty and functionality.

Beyond practical benefits, this hidden induction system offers cutting-edge aesthetics that will completely transfigure your kitchen. Discover the magic of cooking without limits and immerse yourself in a world of possibilities with Arklam.

En Arklam estamos comprometidos con la innovación y la excelencia en el diseño de soluciones para el hogar que marcan la diferencia. Tras un largo proceso de investigación, estamos emocionados de presentar una verdadera revolución en el mundo de la cocina: nuestro nuevo sistema de inducción oculta para encimeras.

Nos encanta imaginar una cocina sin obstáculos visuales, donde la belleza de la encimera Arklam se mantiene impecablemente intacta. Con nuestro sistema de inducción oculta, esa visión se convierte en realidad. Ya no será necesario sacrificar la estética por la funcionalidad: ahora se puede disfrutar de lo mejor de ambos mundos.

¿Cómo funciona?

El sistema de inducción oculta de Arklam es ingeniosamente simple, pero increíblemente efectivo. **Diseñado para integrarse perfectamente en nuestras encimeras**, este sistema permite cocinar directamente sobre la superficie de Arklam sin necesidad de ningún tipo de obstáculo visible.

Sobre una superficie completamente plana y uniforme, puedes colocar tus ollas y sartenes directamente sobre la encimera sin ninguna interrupción visual. Con la tecnología de inducción oculta de Arklam, la energía se transfiere directamente a tus utensilios de cocina a través de la encimera, permitiéndote cocinar de manera eficiente y sin esfuerzo.

Descubre la magia de cocinar sin límites visuales y sumérgete en un mundo de posibilidades con Arklam. Experimenta la innovación hoy mismo y transforma tu cocina en un espacio de belleza y funcionalidad incomparables.

Más allá de los beneficios prácticos, este sistema de inducción oculta ofrece una estética de vanguardia que transformará por completo tu cocina. Descubre la magia de cocinar sin límites y sumérgete en un mundo de posibilidades con Arklam.

Concealed induction cooking zone module available in two sizes: **Ø 210 or 260 mm**

Módulo de inducción oculto de zona de cocción disponible en dos tamaños: **Ø 210 ó 260 mm**

Only for sintered stone 12 mm thick
***NOT SUITABLE FOR POLISHED FINISH**

Solo para piedra sinterizada 12 mm de espesor
***NO APTO ACABADO POLISHED**

| CHARACTERISTICS | | CARACTERÍSTICAS | | | | | |
|--|---------------------------------|--|-------------|--|-------------------------------|-------------------------|-------------|
| Induction module with intelligent temperature sensors | | Módulo inducción con sensores de temperatura inteligentes | | | | | |
| LCD display | | Pantalla LCD | | | | | |
| 7 cooking modes, with programming of up to 4 hours | | 7 modos de cocción, con programación de hasta 4 horas | | | | | |
| Acoustic warning of each action, end of cooking and statuses | | Avisador acústico de cada acción, finalización de cocinado y estados | | | | | |
| Double lock (child lock and lock while cooking) | | Doble bloqueo (bloqueo niños y bloqueo mientras cocinas) | | | | | |
| Automatic shut-off, after two minutes of inactivity | | Apagado automático, después de dos minutos de inactividad | | | | | |
| Residual heat warning | | Aviso de calor residual | | | | | |
| Quiet | | Silencioso | | | | | |
| Power adjustment in all cooking modes | | Regulación de potencia en todos los modos de cocinado | | | | | |
| Automatic container detection | | Detección de recipiente automático | | | | | |
| Easy installation system | | Sistema de fácil instalación | | | | | |
| INDUCTOR DIMENSIONS | | CONTROLLER DIMENSIONS | | DIMENSIONES INDUCTOR | | DIMENSIONES CONTROLADOR | |
| MCMF0025V01 | MCMF0035V01 | MCMF00V01 | MCMF0025V01 | MCMF0035V01 | MCMF00V01 | MCMF0025V01 | MCMF0035V01 |
| Height 65 mm | | Height 64 mm | | Altura 65 mm | | Altura 64 mm | |
| Diameter 285 mm | | Width 135 mm | | Diámetro 285 mm | | Anchura 135 mm | |
| Net weight (kg): 2 approx. | Net weight (kg): 2,1 approx. | Depth 27 mm | | Peso neto (kg): 2 aprox. | Peso neto (kg): 2,1 aprox. | Profundidad 27 mm | |
| TECHNICAL SPECIFICATIONS | | | | ESPECIFICACIONES TÉCNICAS | | | |
| Power rating (V): 220-240 | | | | Tasa de potencia (V): 220-240 | | | |
| Frequency (Hz): 50 | | | | Frecuencia (Hz): 50 | | | |
| Maximum power rating (W): Ø 210 - 2500 Ø 260 - 3500 | | | | Potencia nominal máxima (W): Ø 210 - 2500 Ø 260 - 3500 | | | |

The box includes: Inductor (1), Connecting cable (2), Power cable AC 220V (3) y Controller (4)

Las caja incluye: Inductor (1), Cable de conexión (2), Cable de alimentación AC 220V (3) y Controlador (4)

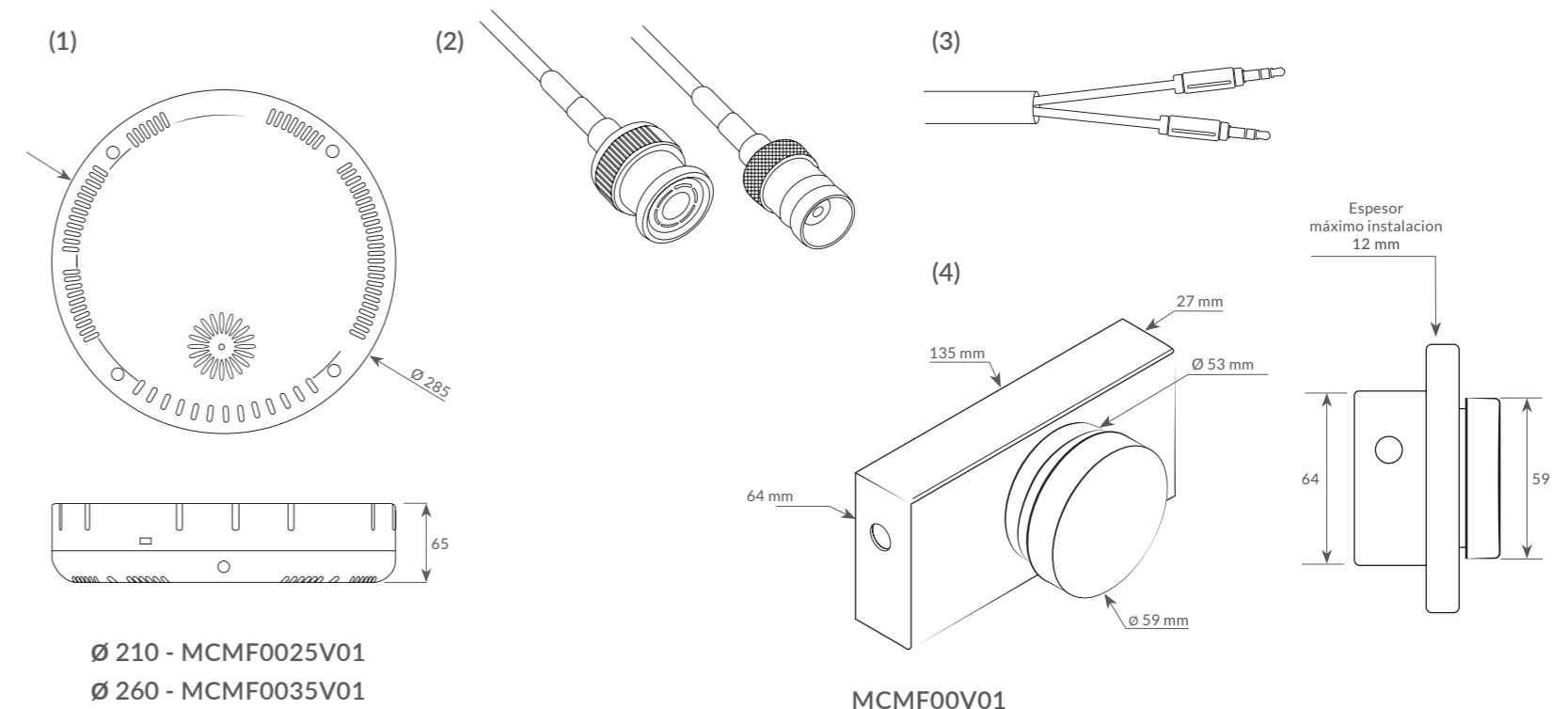



CE Marking declares conformity of our products with the technical and legal requirements for safety
 Marcado CE que declara la conformidad de todos nuestros productos con los requisitos legales y técnicos en materia de seguridad.



CCC Certificate that guarantees that our products meet the standard of radioactivity.
 Certificado CCC que avala que nuestros productos cumplen con el estándar de radioactividad.



Certificate of content in COVs which states that our products are exempt and belong to type A.
 Certificado del contenido en COVs que declara que nuestros productos están exentos y son de tipo A.



LEED certificate that guarantees compliance with a set of rules on the use of strategies aimed at sustainability in buildings.
 Certificado LEED que avala el cumplimiento de un conjunto de normas sobre la utilización de estrategias encaminadas a la sostenibilidad en edificios.



SGS Certification, for implementing and maintaining a Quality Management System in the field of design, development, manufacture and marketing of ceramic tiles that meet fulfills the requirements of the following standard ISO 9001:2015 Register Number ER-0498/2020.
 Certificación de SGS para la aplicación y mantenimiento de un Sistema de Gestión de Calidad en el ámbito de diseño, desarrollo, fabricación y comercialización de baldosas cerámicas que cumplen con los requisitos de Norma ISO 9001:2015 Número de registro: ER-0498/2020.



In compliance with UNE normative documents created in the Technical Committees for Standardization of the Spanish Association for Standardization and Certification.
 En cumplimiento con los documentos normativos UNE creados en los Comités Técnicos de Normalización de la Asociación Española de Normalización y Certificación.



DAPcons certification, EPD ecolabeling programme for pioneering construction in Spain which follows European guidelines and is regulated by ISO 14025 and 15804 standards.
 Certificación DAPcons, programa de ecoetiquetado de EPD de la construcción pionero en España que sigue las directrices europeas y regulado por las normas ISO 14025 y 15804.



Technical Approval Document - DIT
 Documento de Idoneidad Técnica - DIT.



The AAI includes all environmental aspects, and other related aspects considered by the competent environmental authorities, in accordance with basic state and corresponding autonomous legislation.
 La AAI incluye todos los aspectos ambientales, y aquellos otros relacionados que consideren las autoridades ambientales competentes, de acuerdo con la legislación básica estatal y las correspondientes autonómicas.



NSF certification assures suppliers, retailers, regulators and consumers that an independent organisation has reviewed the manufacturing process and determined that the product meets specific standards of safety, quality, sustainability or performance.
 La certificación de NSF asegura a los proveedores, minoristas, entes reguladores y consumidores que una organización independiente ha revisado el proceso de fabricación y ha determinado que el producto cumple con estándares específicos de seguridad, calidad, sostenibilidad o desempeño.



A permit, issued by SASO, to use the Quality Mark on products, which verifies that the facility has an effective management system that ensures production conformity with the General Technical Regulation, granting procedure and Saudi standard specification.
 Permiso, expedido por SASO, para utilizar la marca de calidad en los productos, que verifica que la instalación dispone de un sistema de gestión eficaz que garantiza la conformidad de la producción con el Reglamento Técnico General, el procedimiento de concesión y la especificación de la norma saudí.



CERTIFICATIONS & AWARDS

CERTIFICADOS Y DISTINCIONES



PREMIO nan
 arquitectura y construcción
 AL MEJOR MATERIAL PARA PAVIMENTO Y REVESTIMIENTO
 2018



2018



Cámara
 Castellón

PREMIO A LA EXPORTACIÓN PYME EXPORTADORA

2017



CDI CV COLEGIO DE DISEÑADORES DE INTERIOR C.VALENCIANA



EA D COLECTIVO DE EMPRESAS ASOCIADAS PARA EL DISEÑO



AMC
 Asociación de Mobiliario de Cocina





Arkلام reserves the right to make changes in this catalogue for the benefit of the product and the customer. All names, measures and benchmarks of the pieces are also available on the website, this avoiding typographical error that may have occurred at the time of printing this catalogue. Due to printing processes, the colors of the pieces represented, may have a slight variation from the original color.

In accordance with current legislation, the total or partial reproduction of this publication by any means or procedure, computer processing or any form of transfer of the same without prior written permission of the copyright holders are prohibited.

All images and content in this publication are the property of Saniceramic Group.

Saniceramic Group reserves all rights and, in particular, those of reproduction, distribution, public communication and transformation, even partial.

© 2025 Saniceramic Group. All rights reserved. Re-edited in January.

Arkلام se reserva el derecho de introducir modificaciones en este catálogo en beneficio del producto y del cliente. Todos los nombres, medidas y referencias de las piezas se encuentran también disponibles en nuestra página web, evitando de este modo errores tipográficos que se hayan podido producir a la hora de imprimir este catálogo. Debido a los procesos de impresión, los colores de las piezas representadas, pueden sufrir una leve variación respecto al color original.

Quedan prohibidos, conforme a la legislación vigente, la reproducción total o parcial de esta publicación por cualquier medio o procedimiento, el tratamiento informático o cualquier forma de cesión de la misma sin autorización previa y por escrito de los titulares del copyright.

Todas las imágenes y el contenido de esta publicación son propiedad de Saniceramic Group.

Saniceramic Group se reserva todos los derechos y, en particular, los de reproducción, distribución, comunicación pública y transformación, incluso parcial.

© 2025 Saniceramic Group. Todos los derechos reservados. Reeditado en enero.

www.arklam.com | arklam@arklam.com
Tel.: 0034 964 913 171 | Fax.: 0034 964 657 426
Ctra. de Alcora, Km. 7,5 | 12130 Sant Joan de Moró
Castellón (Spain)

Together on social networks
Juntos en redes sociales





Follow us! · ¡Síguenos!



www.arklam.com · arklam@arklam.com · Tel.: 0034 964 913 171 · Fax.: 0034 964 657 426
Ctra. de Alcora, Km. 7,5 · 12130 Sant Joan de Moró · Castellón (Spain)